

POWER TRANSMISSION COMPACT CATALOGUE



A man with a beard and brown hair, wearing a blue and black plaid shirt and a bright yellow high-visibility vest with reflective stripes, stands in a large, bright industrial space. He is holding a clipboard and a pair of black gloves. A pair of red earplugs is hanging from his neck. The background shows a large, open industrial building with a high ceiling and skylights.

Maintenance-free

Norbert, 42, foreman

Since 1948, the Optibelt company has been manufacturing a wide variety of drive belts, drawing on more than a century of experience of working with rubber. Constant investments in materials research and production technology as well as growing knowledge of the constraints associated with the various fields of application have led to the further development of the belt into a high-tech drive element, which has allowed the performance limits of the machines to be pushed further and further.

8633302620

8 PRODUCTION SITES IN 6 COUNTRIES 33 SALES LOCATIONS IN 30 COUNTRIES 26 LOGISTICS CENTRES IN 20 COUNTRIES

ONE WORLD – ONE QUALITY

Optibelt stands internationally for excellent brand quality. To ensure that the label "Made by Optibelt" always meets the same high standard around the globe, the Arntz Optibelt Group has 8 production sites in 6 countries, all of which are equally committed to a demanding quality management system. In order to ensure that there are no deviations in product properties and quality, the same binding guidelines apply to all locations with regard to the manufacturing processes and the quality specifications for the selection and processing of the corresponding raw materials. This means that every single customer worldwide can rely on the outstanding Optibelt quality across all industries.

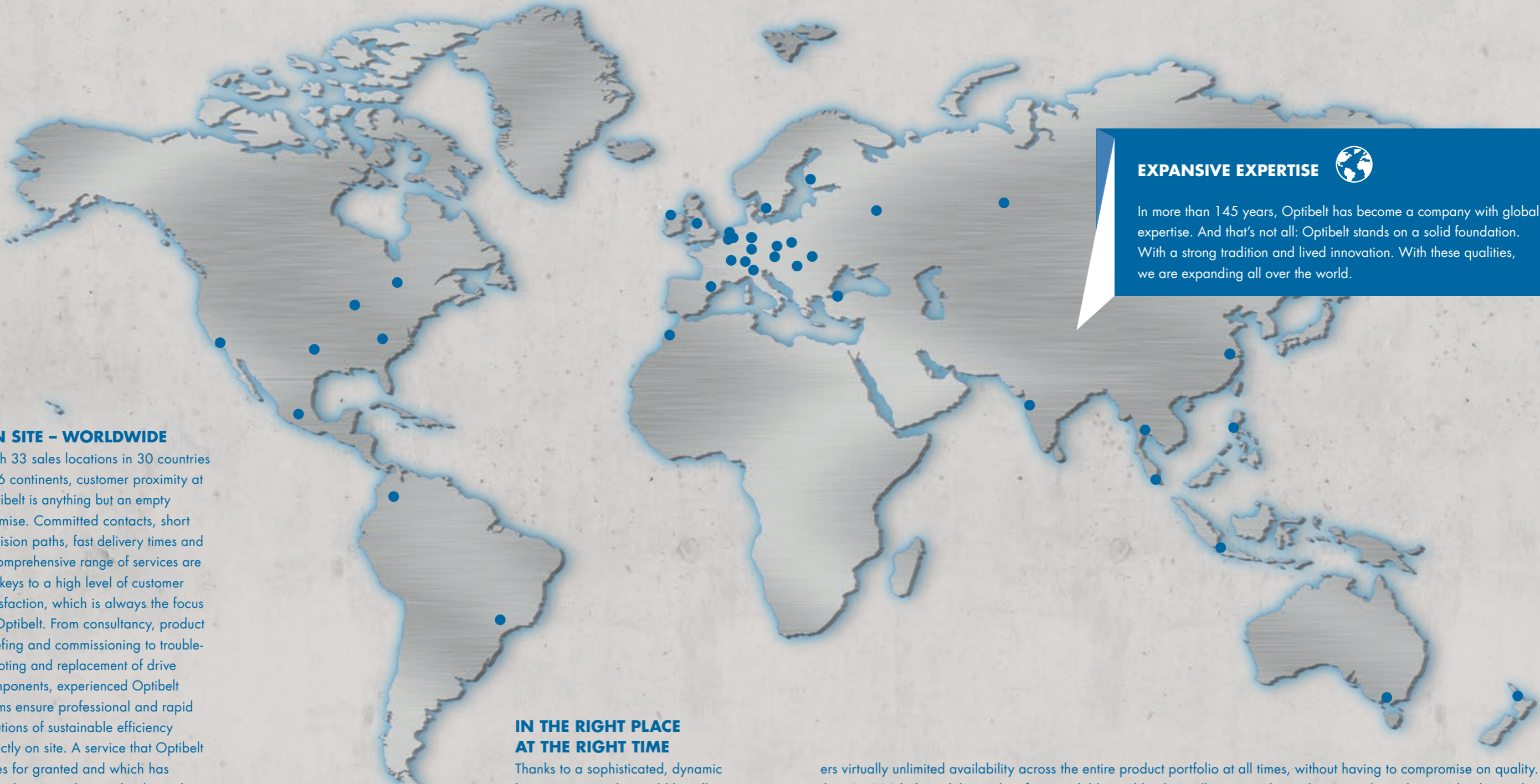

ON SITE – WORLDWIDE

With 33 sales locations in 30 countries on 6 continents, customer proximity at Optibelt is anything but an empty promise. Committed contacts, short decision paths, fast delivery times and a comprehensive range of services are the keys to a high level of customer satisfaction, which is always the focus at Optibelt. From consultancy, product briefing and commissioning to troubleshooting and replacement of drive components, experienced Optibelt teams ensure professional and rapid solutions of sustainable efficiency directly on site. A service that Optibelt takes for granted and which has already received several independent awards.

IN THE RIGHT PLACE AT THE RIGHT TIME

Thanks to a sophisticated, dynamic logistics system, the world literally becomes a village for Optibelt. With 26 logistics centres in 20 countries, the Arntz Optibelt Group offers its custom-

ers virtually unlimited availability across the entire product portfolio at all times, without having to compromise on quality. More than 25,000 belt models are therefore available worldwide at all times, and are also promptly implemented in line with customer requirements and costs. Speed, flexibility and product diversity are therefore not mutually exclusive, which only underlines Optibelt's high status as a globally sought-after partner for innovative drive solutions.

EXPANSIVE EXPERTISE



In more than 145 years, Optibelt has become a company with global expertise. And that's not all: Optibelt stands on a solid foundation. With a strong tradition and lived innovation. With these qualities, we are expanding all over the world.

THE WORLD IS IN MOTION. WE ARE THE DRIVE!

The requirements for Optibelt products are as varied as the industries in which they are used. From robust kraftbands for agricultural machinery to high performance V-belts used in road construction and precise timing belts for the textile industry – Optibelt products are at home in many different industries and endure extreme conditions.

Wherever dust, heat, cold, abrasive chemicals or extremely high speeds put the material to the test, Optibelt shows its strengths. Wherever smooth, low vibration running is called for in spite of high speeds, Optibelt ensures lossless operation. Wherever extreme tensile forces or strong friction have to be defied, Optibelt delivers untiring performance. Whether enormous and powerful or delicate and precise.



LOGISTICS AND SERVICES

Page 4 and 5



WRAPPED V-BELTS AND KRAFTBANDS

Page 8 to 23



PERFORMANCE COMPARISON FRICTIONAL

Page 10 and 11



S=C Plus

Page 18 and 19



RAW EDGE V-BELTS AND KRAFTBANDS

Page 24 to 29



RIBBED BELTS

Page 30 to 33



RUBBER TIMING BELTS

Page 34 to 49



PERFORMANCE COMPARISON FORM-FIT

Page 36 and 37



OMEGA 2iN1

Page 38 and 39



POLYURETHANE TIMING BELTS

Page 50 to 57



SPECIAL BELTS

Page 58 to 62



SPECIAL BELTS

Page 63 to 67



METAL

Page 68 to 75



COUPLINGS

Page 76 to 79



SERVICE TOOLS

Page 80 to 85

WRAPPED V-BELTS AND KRAFTBANDS

optibelt RED POWER 3 – MAINTENANCE-FREE HIGH PERFORMANCE

Wrapped V-belts consist of a rubber core, tension cord, rubber top surface and an enveloping fabric wrap. The wrapping is particularly gentle on the flanks of the belt pulleys. The design of the tension cords determines the performance and ease of maintenance of the drive. The **optibelt RED POWER 3**, for example, uses a transverse fibre blend that can withstand high dynamic loads. Flexibility, abrasion resistance and bending flexibility included.



Maintenance-free



S=C Plus set-constant,
always at the nominal
dimension



Powerful



Use in drive designs



97 % efficiency

PERFORMANCE FOR EVERY REQUIREMENT

SPECIALLY DEVELOPED FOR HEAVY-DUTY APPLICATIONS IN MECHANICAL ENGINEERING, THE COMMERCIALY AVAILABLE NARROW V-BELTS AND optibelt RED POWER 3 PROVIDE POWERFUL DRIVE SOLUTIONS FOR EVERY REQUIREMENT.

Both belts operate at a constant rate with an efficiency of almost 97 percent, while commercially available V-belts only achieve a maximum of 94 percent. Smooth power transmission results in more power, while at the same time, using less energy. In addition, the commercially available narrow V-belt offers a favourable price-performance ratio with considerably reduced follow-up costs due to extended maintenance intervals compared to commercially available V-belts.

The **optibelt RED POWER 3** requires a higher initial investment, but is maintenance-free and especially the best choice when high performance is required with a slim design. Since it achieves up to 50 percent higher performance compared to standard V-belts, **optibelt RED POWER 3** belts achieve the same power peaks in identical drive situations without any loss using fewer belts overall. This results in sustainable overall savings in terms of materials and maintenance.

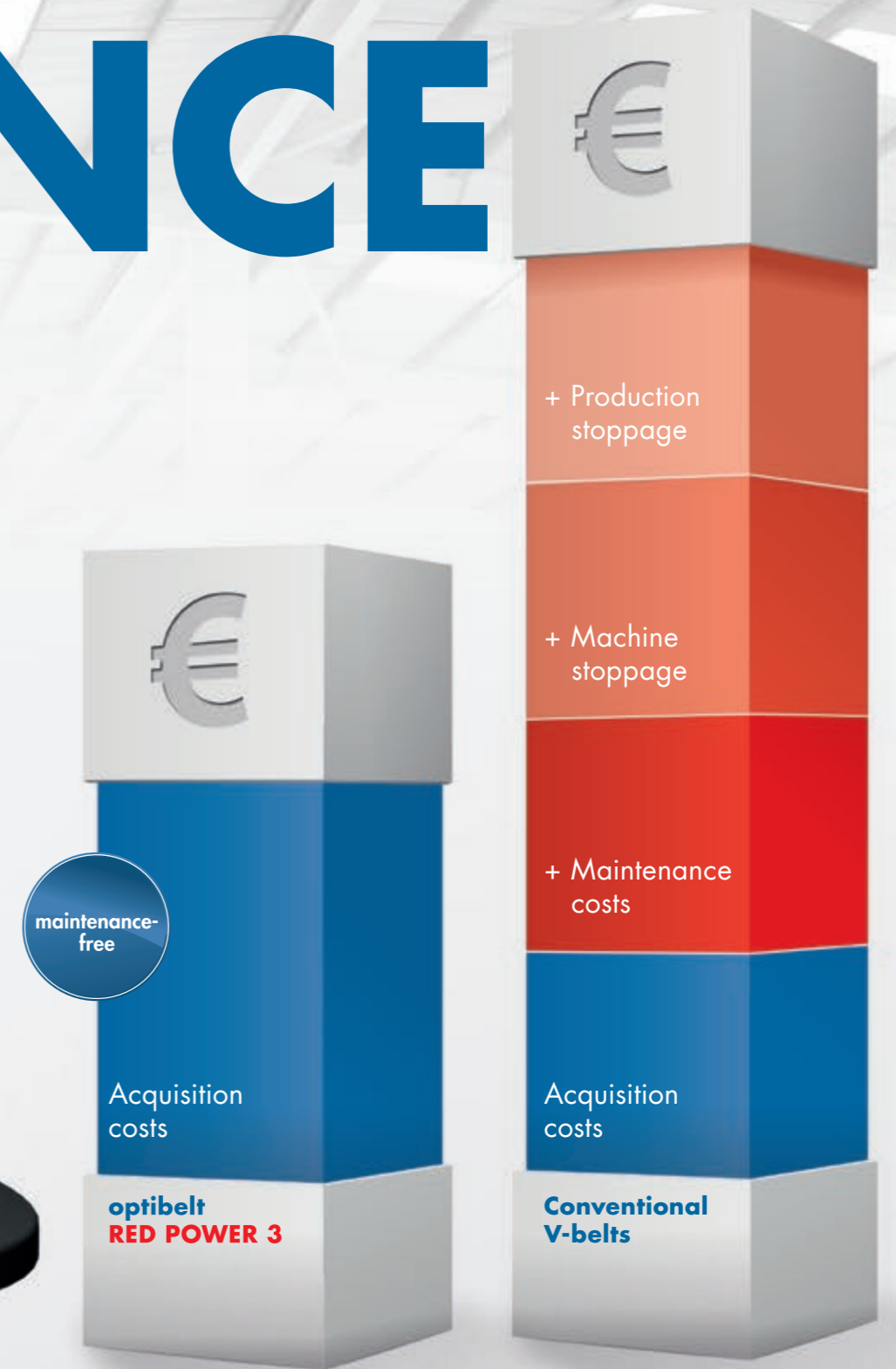

optibelt RED POWER 3 S=C Plus

HIGH PERFORMANCE WEDGE BELTS



Maintenance-free **optibelt RED POWER 3** V-belts and kraftbands have an up to 50% higher power transmission capacity compared to wedge belts in their standard technical design. Thanks to lower maintenance costs and a reduced demand for replacements due to fewer belts and smaller pulleys, up to 35% cost savings are possible. This means that up to 18% of the costs can be saved even for new acquisitions. Additional cost savings result from the space-saving design as well as minimised shafts and bearings.

Advantages and Characteristics

- maintenance-free; optimum tension over the entire lifetime
- new version: more compact, affordable structure compared to drives with conventional wedge belts
- S=C Plus, always the right length for sets without measuring
- up to 97% efficiency
- suitable for back bend idlers
- problem solver: much longer service life and clearly reduced maintenance requirement when used in overloaded existing drives
- temperature-resistant from -30 °C to +100 °C
- meets ISO 1813 anti-static requirements

Profiles and Belt Length Ranges

SPZ	1202 – 3550 mm
SPA	1207 – 4000 mm
SPB	1250 – 8000 mm
SPC	2000 – 10000 mm
3V	47.5 – 140 in /
9N	1206 – 3556 mm
5V	53 – 315 in /
15N	1346 – 8001 mm
8V	100 – 475 in /
25N	2540 – 12065 mm

Other profiles and lengths on request

optibelt RED POWER 3 S=C Plus in cross section

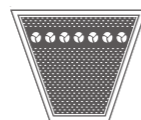

optibelt KS V-GROOVED PULLEYS

for cylindrical bore or for **optibelt TB taper bushings**, special pulleys on request

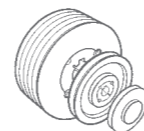

optibelt RED POWER 3 Classic S=C Plus

CLASSIC HIGH-PERFORMANCE V-BELTS



optibelt **RED POWER 3 Classic S=C Plus** has a classic belt section and replaces standard technical models of classic belts in existing drives.

These belt profiles allow a flatter design compared to wedge belts, making smaller pulley diameters possible despite an identical upper width. The minimum pulley diameters are correspondingly smaller.

Optibelt RED POWER 3 Classic belts meet the well-known close S=C Plus nominal length tolerances and so are always the right length for sets without re-measuring.

Applications

As a classic among V-belts, **optibelt RED POWER 3 Classic** is used in many general mechanical engineering applications, mainly in existing drives in America and Asia. Classic belt sections are still very common there.

Advantages and characteristics

- S=C Plus, always the right length for sets without measuring
- Maintenance-free, optimum tension over the entire lifespan
- Meets ISO 1813 anti-static requirements
- Allows smaller pulley diameters than with wedge belts
- Up to 20% higher performance than in technical standard version

Sections and belt length ranges

- A 52–120 in
- B 52–148 in

Other sizes available on request

optibelt RED POWER 3 Classic S=C Plus in cross section

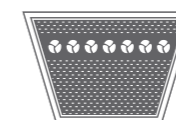

optibelt KS V-GROOVE PULLEYS

for cylindrical bore or for **optibelt TB taper bushes**, special pulleys on request

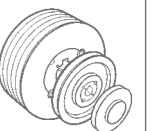

optibelt BLUE POWER

HIGH PERFORMANCE WEDGE BELTS



The new **optibelt BLUE POWER** high performance wrapped wedge belt has a high-strength aramid cord, and is suitable as an individual belt, in a set or as a kraftband and is particularly suited for large, heavily loaded drives.

The **optibelt BLUE POWER** wedge belt has about twice the capacity of a wedge belt in the standard technical design. This translates to up to 100% extra performance.

If several wedge belts are used next to each other, they must be ordered as a set.

Advantages and Characteristics

- new version: ultra-compact, ultra cost-efficient design possible compared to drives with wrapped wedge belts
- problem solver: much longer lifetime and reduced maintenance when used in existing overloaded systems
- suitable for back bend idlers
- powerful: approx. 100% higher performance compared to standard wedge belt
- suitable for extremely heavily loaded drives
- temperature-resistant from -30 °C to +100 °C
- meets ISO 1813 anti-static requirements
- increased chemical resistance

Profiles and Belt Length Ranges

SPB	1500 – 8000 mm
SPC	2000 – 9000 mm
8V	160 – 355 in /
25N	4064 – 9017 mm

Other profiles and lengths on request

optibelt BLUE POWER in cross section

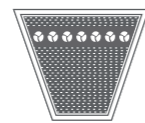

optibelt KS V-GROOVED PULLEYS for cylindrical bore or for **optibelt TB taper bushings**, special pulleys on request

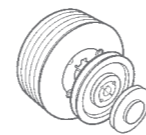

optibelt SK S=C Plus

WEDGE BELTS



The **optibelt SK** wrapped wedge belt was developed particularly with mechanical engineering in mind, where it replaces the classic V-belt. It transmits some 50% more power in comparison and so makes it possible to use more compact and lower-priced drives as a result when making new acquisitions.

Existing drives, such as B/17, with a classic section can be replaced with the SPB wedge belt section. In order to do so, it is essential to take account of the minimum pulley diameter required for wedge belts, which is greater than for classic V-belts, despite its identical width, due to the increased thickness of the wedge belt. It is also necessary to use suitable pulleys for wedge belts.

The wrapped wedge belt has the same outstanding attributes of the Optibelt **S=C Plus**, with an efficiency of nearly 97%, and is always the right length for sets without measuring.

Advantages and Characteristics

- high efficiency
- considerable energy-saving
- excellent running properties
- superior price-performance ratio
- low maintenance costs
- S=C Plus, always the right length for sets without measuring

Profiles and Belt Length Ranges

SPZ	487 – 3550 mm
SPA	732 – 4500 mm
SPB	1250 – 8000 mm
SPC	2000 – 12500 mm
3V	25 – 140 in /
9N	635 – 3556 mm
5V	53 – 355 in /
15N	1346 – 9017 mm
8V	100 – 500 in /
25N	2540 – 12700 mm

Other lengths on request

optibelt SK S=C Plus in cross section



optibelt KS V-GROOVED PULLEYS for cylindrical bore or for **optibelt TB taper bushings**, special pulleys on request

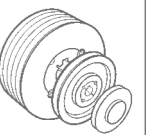

optibelt VB S=C Plus

CLASSIC V-BELTS



Due to its versatile applications, the **optibelt VB** is the classic model among drive belts. The qualities of this product really come into their own with difficult drives in agricultural machines just as with unusual drive solutions, such as V-flat drives in mechanical engineering.

optibelt VB classic V-belts are **S=C Plus** and are always the right length for sets without measuring.

Advantages and Characteristics

- excellent operating reliability
- up to 97% efficiency
- optimum operating features
- uniform power transmission
- abrasion-resistant cover fabric
- many special designs
- for universal application

Profiles and Belt Length Ranges

5	200 – 610 mm
Y/6	295 – 865 mm
8	335 – 1270 mm
Z/10	312 – 2522 mm
A/13	437 – 5030 mm
B/17	610 – 7140 mm
20	950 – 6050 mm
C/22	1148 – 8058 mm
25	1460 – 9060 mm
D/32	2075 – 11275 mm
E/40	3080 – 12580 mm

Other lengths on request

optibelt VB S=C Plus
in cross section



optibelt KS V-GROOVED PULLEYS

for cylindrical bore or
for **optibelt TB** taper bushings,
special pulleys on request

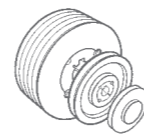

optibelt DK

DOUBLE SECTION V-BELTS

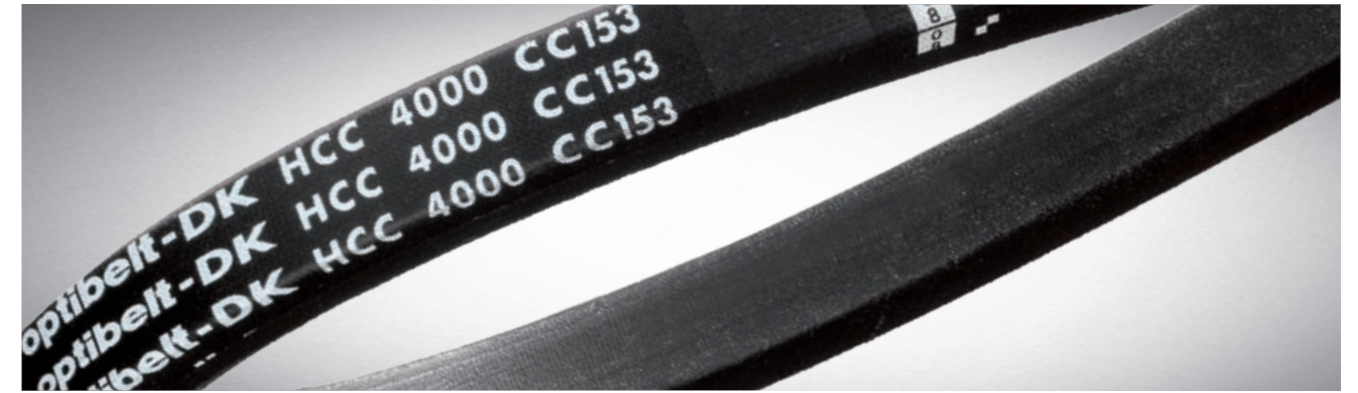

Due to the tensile cord situated in the centre of the belt section, **optibelt DK** double section V-belts are extremely flexible and low-stretch.

They are therefore particularly suitable for use where two-way bending occurs.

optibelt DK double section V-belts are used if several pulleys are located on one level and the direction of rotation of one or several driven pulleys is to be changed without crossing the belt. The **optibelt DK** double section V-belt is ideally suited for use in typical serpentine designs.

Special versions with different belt structures are possible. Double section V-belts are mainly used for agricultural machinery. They are increasingly used, however, in mechanical engineering.

Advantages and Characteristics

- flexible and low-stretch design
- excellent running properties
- outstanding flexibility
- low-stretch characteristics
- high level of performance

Profiles and Belt Length Ranges

AA / HAA	2000 – 3920 mm
BB / HBB	1980 – 5639 mm
CC / HCC	2280 – 5750 mm
DD / HDD	on request
22 x 22	5180 – 6270 mm
25 x 22	on request

Further dimensions available on request

optibelt DK
in cross section

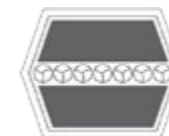

optibelt KS V-GROOVED PULLEYS

for cylindrical bore or
for **optibelt TB** taper bushings,
special pulleys on request

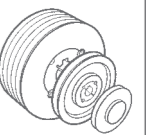

MINIMUM TOLERANCE. MAXIMUM EFFECT.

- **SAVING: SAVES COSTS FOR ARTICLE MAINTENANCE AND STORAGE**
- **WITHOUT EXTRA SET IDENTIFICATION: ONE BELT FOR EACH POSITION**
- **SET CONSTANT: CAN BE USED IN A SET WITHOUT ADDITIONAL MEASUREMENT**



S=C Plus: Due to very close tolerances to the nominal size, our set constant V-belts can be used anywhere without being measured. This is quality made by Optibelt.

THE OPTIBELT

S=C Plus STANDARD

from ± 2 mm (depending on length)



THE PERMITTED

DIN/ISO TOLERANCE

$\pm 10\%^*$



The norm is not enough for us. Because precision is in demand in our business. This is the only way our customers can count on the best. This is why our **S=C Plus** V-belts are closer to the nominal size than standards such as DIN and ISO specify. You cannot buy our **S=C Plus** V-belts as a set. They do not have a set ID. Thanks to the closest tolerances to the nominal dimension, each belt fits anywhere in the set without any additional measurement.



optibelt **SK** S=C Plus



optibelt **VB** S=C Plus



optibelt **RED POWER 3** S=C Plus

THE DIAGRAM SHOWS:

Our belt sizes are closer to the nominal size than all others. The belt dimensions of our competitors are also within the standard range, but our **S=C Plus** V-belts are even closer to the nominal length than the standard specifies for belt sets in multi-groove drives. They have a constant length. It's the one that it says on it. And that is why we called it **S=C Plus**: Set = Constant. Our guarantee for the lowest tolerances.



* at nominal size 5,000 mm

Example: * Nominal size: 5,000 mm, S=C Plus: ± 2 mm, DIN/ISO: ± 50 mm, standard for multi-groove drives: ± 6 mm

optibelt KB RED POWER 3

HIGH PERFORMANCE KRAFTBANDS



Maintenance-free **optibelt RED POWER 3** V-belts and kraftbands achieve an up to 50% higher power transmission capacity compared to wedge belts in standard technical design. Thanks to lower maintenance costs and a reduced demand for replacements due to fewer belts and smaller pulleys, up to 35% cost savings are possible. This means that up to 18% of the costs can be saved even for new acquisitions. Additional cost savings are due to the space-saving design as well as minimised shafts and bearings.

The tension cord consists of a special polyester cord. Thanks to special treatment of the tension cord, the **optibelt RED POWER 3** high performance wedge belt is very low-stretch and maintenance-free so that re-tensioning is not necessary. The transverse fibre blend above and below the tension cord provides especially high dimensional stability. The abrasion-resistant special wrapping fabric improves the flexibility compared to wedge belts in technical standard design.

Advantages and Characteristics

- single belt characteristics
- low-vibration operation
- V-grooved / flat pulley drives
- coupling drives
- conveying jobs

Profiles and Belt Length Ranges

SPB KB	2000 – 8000 mm
SPC KB	3000 – 10000 mm
3V KB	50 – 140 in /
9J	1270 – 3556 mm
5V KB	56 – 315 in /
15J	1422 – 8001 mm
8V KB	100 – 475 in /
25J	2540 – 12065 mm

Other profiles and lengths on request

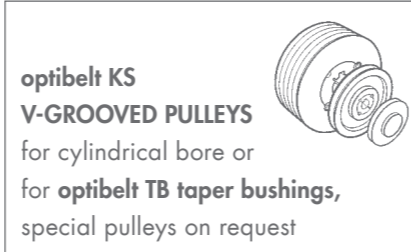
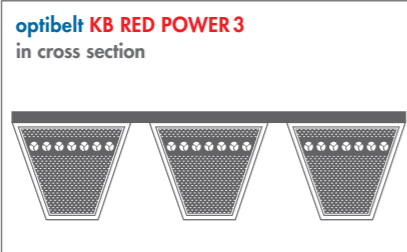

optibelt KB BLUE POWER

HIGH PERFORMANCE KRAFTBANDS



optibelt KB BLUE POWER kraftbands are made of wrapped **optibelt BLUE POWER** high performance wedge belts which are joined together by a highly wear-resistant top surface. This compact drive product is the preferred choice for handling extreme shock loads, large centre distances and vertical shafts.

Depending on the application, up to five ribs may be used per kraftband. If several kraftbands are used next to each other, they must be ordered as a set.

Advantages and Characteristics

- new version: ultra-compact, ultra cost-efficient design possible compared to drives with wrapped wedge belts
- problem solver: much longer lifetime and reduced maintenance when used in existing overloaded systems
- suitable for back bend idlers
- powerful: approx. 100% higher performance compared to **optibelt KB SK** kraftbands
- increased chemical resistance
- suitable for extremely heavily loaded drives
- temperature-resistant from -30 °C to +100 °C
- meets ISO 1813 anti-static requirements
- single belt characteristics
- low-vibration operation
- V-grooved / flat pulley drives
- coupling drives
- conveying jobs

Profiles and Belt Length Ranges

SPB KB	1200 – 4750 mm
SPC KB	1200 – 5600 mm
5V KB	80 – 315 in /
15J	2032 – 8001 mm
8V KB	100 – 475 in /
25J	2540 – 12065 mm

Other lengths on request

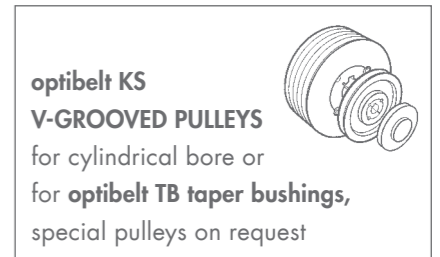
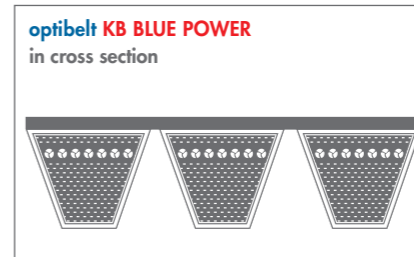

optibelt KB SK

KRAFTBANDS WITH WEDGE BELTS



optibelt KB SK kraftbands consist of single high-quality wrapped belts which are joined together with a top surface. Depending on the application, up to five wedge belts may be used per kraftband.

In special cases, kraftbands with more than five V-belts can be supplied. If several kraftbands are used next to each other, they must be ordered as a set.

optibelt KB SK kraftbands are used above all with extreme shock loads or large centre distances in combination with small pulley diameters and with vertical axes.

Advantages and Characteristics

- single belt characteristics
- low-vibration operation
- V-grooved / flat pulley drives
- coupling drives
- conveying jobs

Profiles and Belt Length Ranges

SPZ	1250 – 3550 mm
SPA	1250 – 4500 mm
SPB	2000 – 8000 mm
SPC	3000 – 12500 mm
3V/9J	50 – 140 in
5V/15J	56 – 355 in
8V/25J	100 – 475 in

Other dimensions on request

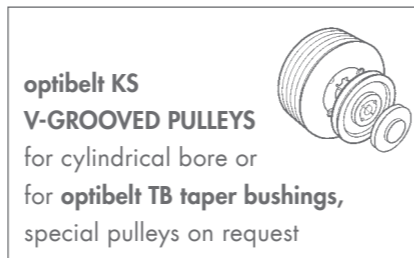
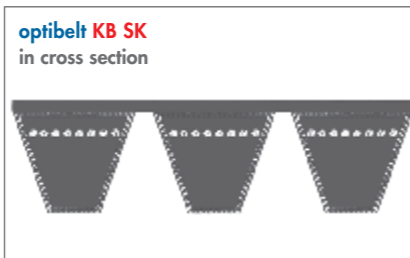

optibelt KB VB

KRAFTBANDS WITH CLASSIC V-BELTS



optibelt KB VB kraftbands consist of single high-quality wrapped belts which are joined together with a top surface. Depending on the application, up to five classic V-belts may be used per kraftband.

In special cases, kraftbands with more than five V-belts can be supplied. If several kraftbands are used next to each other, they must be ordered as a set.

optibelt KB VB kraftbands are used above all with extreme shock loads or large centre distances in combination with small pulley diameters and with vertical shafts.

Advantages and Characteristics

- single belt characteristics
- low-vibration operation
- V-grooved / flat pulley drives
- coupling drives
- conveying jobs

Profiles and Belt Length Ranges

A KB	1200 – 4750 mm
B KB	1200 – 5600 mm
C KB	2286 – 6300 mm
D KB	2500 – 17780 mm
E KB	3000 – 12500 mm

Other dimensions on request

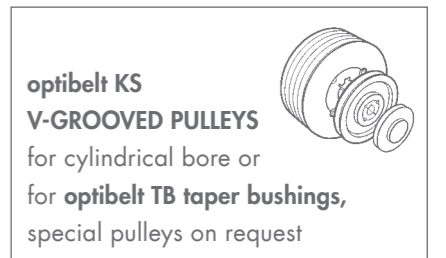
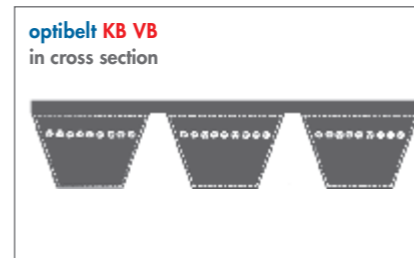

THE NEXT GENERATION

The maintenance-free **optibelt SUPER XE-POWER PRO M=S** is one of the best performing drive belts on the market. The innovative design of this open-flank V-belt opens up new scope in the design of frictional drives, even on the smallest pulley diameters, in extreme temperature ranges and at maximum speeds.

PROFILES

XPZ; XPA; XPB; XPC;
3VX/9NX; 5VX/15NX

587 – 3550 mm

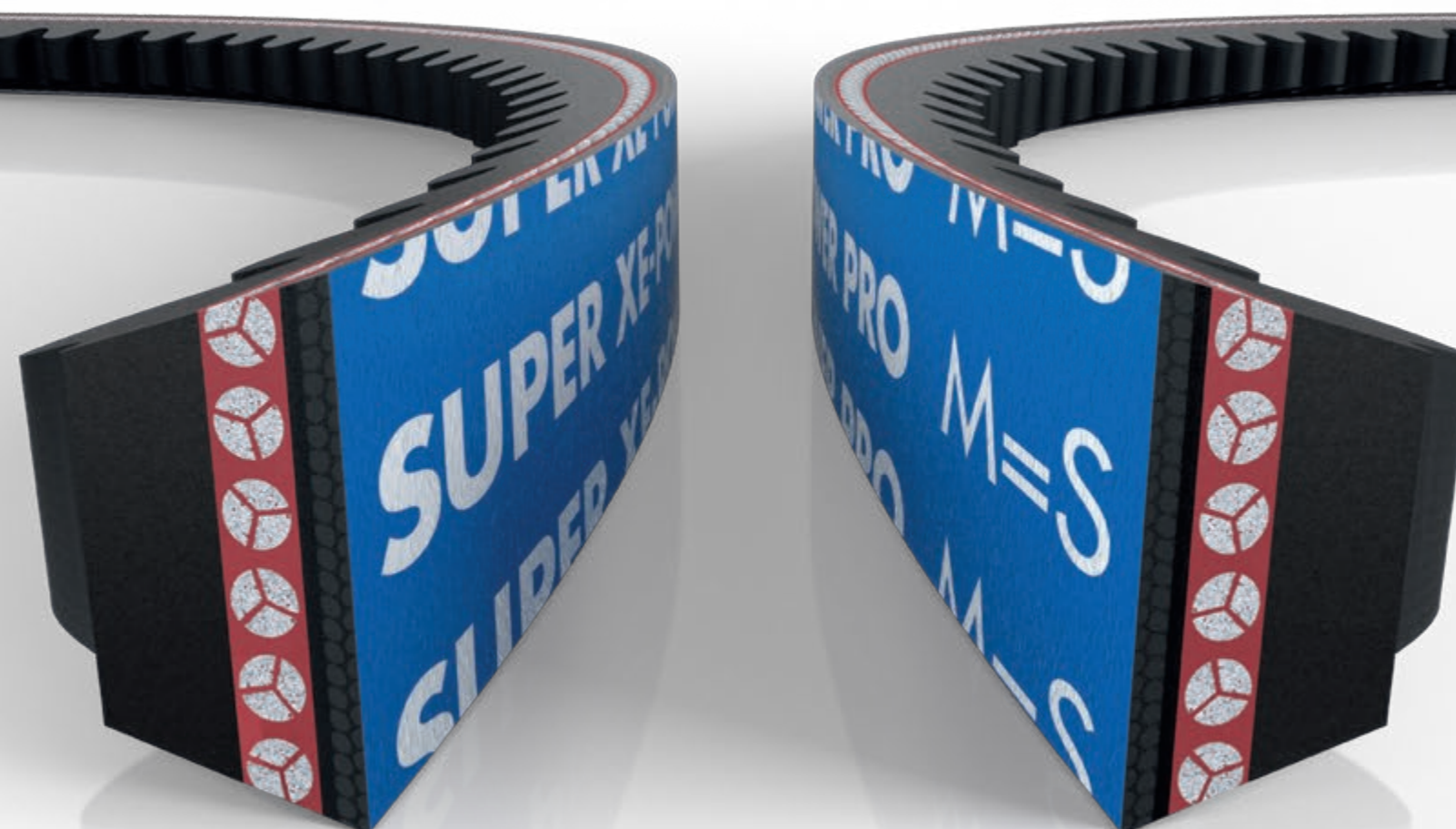

optibelt SUPER XE-POWER PRO M=S

HIGH PERFORMANCE WEDGE BELTS



Continuous further development of the manufacturing process, improved materials, a low-stretch polyester tensile member and optimised serration form the basis of this new generation of belts.

The **optibelt SUPER XE-POWER PRO M=S** makes complex drive solutions possible in all areas of mechanical engineering under the most difficult conditions and extreme operational demands.

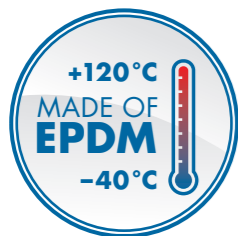

Advantages and Characteristics

- belt made of EPDM
- temperature-resistant from -40 °C to +120 °C
- red cushion compound for optimised bonding of the tension cord
- maintenance-free
- suitable for back bend idlers
- high power transmission with up to 20% higher efficiency compared to standard V-belts
- M=S is always the right length for sets without measuring
- efficiency-optimised
- optimised, exceptionally smooth running properties
- static conductive; meets ISO 1813 antistatic requirements
- ATEX and RoHS compliant

Profiles and Belt Length Ranges

XPZ	587 – 3550 mm
XPA	707 – 3550 mm
XPB	1250 – 3550 mm
XPC	2000 – 3550 mm
3VX/9NX	25 – 140 in
5VX/15NX	50 – 140 in

Other sizes available on request

optibelt SUPER XE-POWER PRO M=S in cross section



optibelt KS V-GROOVED PULLEYS
for cylindrical bore or for **optibelt TB taper bushings**, special pulleys on request

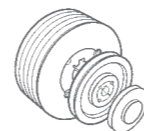

optibelt SUPER X-POWER M=S

HIGH PERFORMANCE WEDGE BELTS



The set-constant **optibelt SUPER X-POWER M=S** V-belt is raw edge and moulded cogged. The belt is suitable for its reliability, durability and efficiency for demanding, multi-grooved drives.

Due to their identical length, the belts are always the right length for sets without measuring and are designed for extremely high loads.

Advantages and Characteristics

- high performance, raw edge, moulded cogged
- up to 15% higher performance
- extremely low-stretch
- extended maintenance intervals
- optimised running characteristics
- excellent resistance to oil and heat
- M=S set-constant; is always the right length for sets without measuring
- energy and weight saving
- meets ISO 1813 anti-static requirements

Profiles and Belt Length Ranges

XPZ	587 – 3550 mm
XPA	707 – 3550 mm
XPB	1250 – 3550 mm
XPC	2000 – 3550 mm
3VX	25 – 140 in /
9NX	635 – 3556 mm
5VX	50 – 140 in /
15NX	1270 – 3556 mm

Other dimensions on request

optibelt SUPER X-POWER M=S in cross section

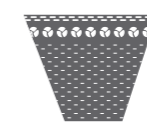

optibelt KS V-GROOVED PULLEYS
for cylindrical bore or for **optibelt TB taper bushings**, special pulleys on request

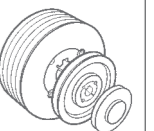

optibelt SUPER KBX-POWER

HIGH PERFORMANCE KRAFTBANDS



optibelt SUPER KBX-POWER kraftbands consist of optibelt SUPER X-POWER V-belts which are joined together with a highly wear-resistant top surface.

These kraftbands display considerably improved tension behaviour compared to conventional raw edge kraftbands. Depending on the application, up to five ribs may be used per kraftband. If several kraftbands are used next to each other, they must be ordered as a set.

optibelt SUPER KBX-POWER kraftbands are recommended for use with extreme impact loads, vertically running axes, large centre distances and many other special tasks in the field of mechanical and vehicle engineering. The power ratings correspond to the profiles of optibelt SUPER X-POWER V-belts.

Advantages and Characteristics

- compact drive solutions
- increased power transmission capacity
- low-stretch / low maintenance
- optimised running characteristics
- small pulley diameter / large belt span

Kraftbands

- single belt characteristics
- low-vibration operation
- V-grooved / flat pulley drives
- coupling drives
- conveying jobs

Profiles and Belt Length Ranges

3VX KB	50 – 140 in /
9JX	1270 – 3556 mm
5VX KB	50 – 140 in /
15JX	1270 – 3556 mm

Other dimensions on request

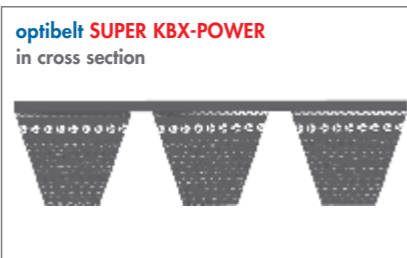

optibelt KS V-GROOVED PULLEYS for cylindrical bore or for optibelt TB taper bushings, special pulleys on request

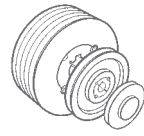

optibelt VARIO POWER

VARIABLE SPEED BELTS

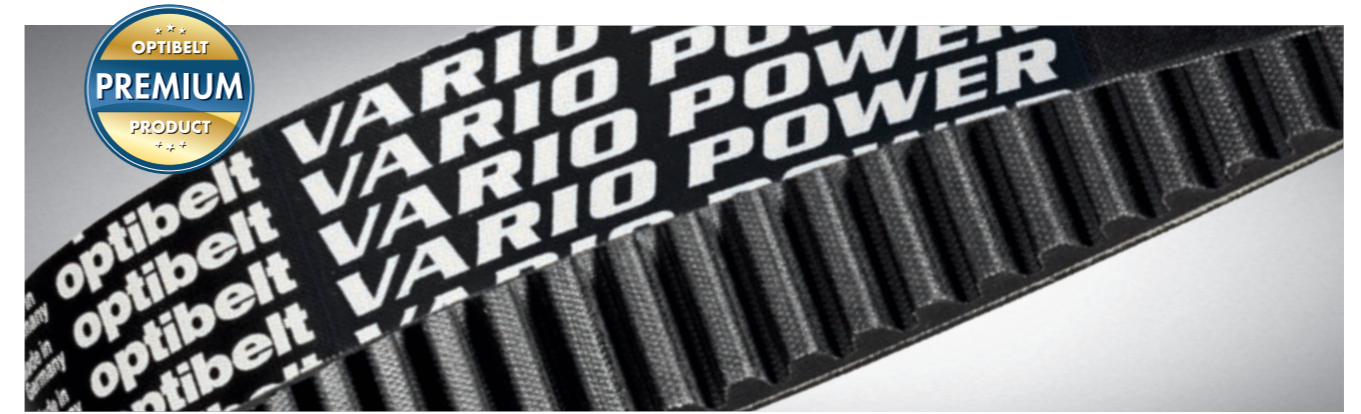

The base compound consists of a poly-chloroprene rubber compound with fibres inlaid transversely to the running direction. The high-quality and extremely low-stretch polyester or aramid tension cord is embedded in a cushion compound. It is reinforced with a fabric outer surface, and the transverse fibres incorporated provide transverse rigidity without sacrificing flexibility.

optibelt VARIO POWER variable speed belts are the preferred choice for infinitely variable speed control. The special belt structure allows high dynamic loads, superior power transmission capability and good control characteristics.

Also available as a double-sided belt.

Advantages and Characteristics

- high power transmission
- long service life
- smooth running even at high speeds
- high flexibility
- optimised heat dissipation

Profiles and Belt Length Ranges

Width: from 10 to ~85 mm
 Height: from 5 to ~30 mm
 Inside length: from 550 to ~3500 mm
 Angles: from 22° to 42°
 can be manufactured on request

Other dimensions on request

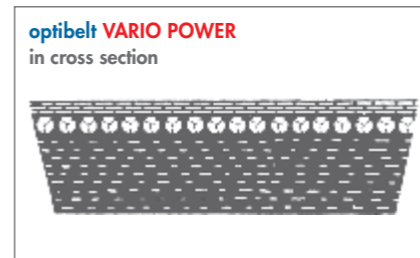

optibelt KS V-GROOVED PULLEYS for cylindrical bore or for optibelt TB taper bushings, variator pulleys on request

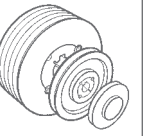

RIBBED BELTS

optibelt RB – FLEXIBLE SERVICE PROVIDER

The ribbed belt combines the high flexibility of the flat belt with the high performance of the V-belt. The wear-resistant rubber compound ensures smooth running, maximum oil and heat resistance and a long service life.



Very good dynamic power transmission capability



High performance



Low vibration, low noise



Withstands shock loads and short-term overload



High belt speeds are possible



Use with deflection pulleys is possible

optibelt RB

RIBBED BELTS



The **optibelt RB** ribbed belt combines the high flexibility of flat belts with the high performance of V-belts. The V-shaped parallel ribs are made from a wear-resistant rubber compound. The high strength tension cord is designed for the many applications of the ribbed belt.

It is embedded in a rubber adhesive mixture and covers the entire width of the ribbed belt. Fibre-reinforced, wear-resistant rubber compounds ensure quiet operation, oil and heat resistance and a long belt life.

The small minimum pulley diameters meet the requirements of drives with high speed ratios as well as the demands of slow running drives.

Advantages and Characteristics

- very good dynamic power transmission capability
- good coefficient of friction and high performance
- low vibration and noise
- withstands shock loads and short-term overload
- high belt speeds are possible
- can be used with back bend idlers, e.g. in serpentine drives

Profiles and Belt Length Ranges

PH	698 – 2155 mm
PJ	280 – 2489 mm
PK	630 – 2845 mm
PL	954 – 6096 mm
PM	2286 – 15266 mm

Other dimensions on request

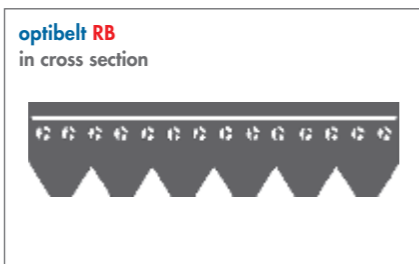

RIBBED BELT PULLEYS
all standard pulleys,
special pulleys on request

optibelt ERB

ELASTIC RIBBED BELTS



Elastic ribbed belt profiles EPH and EPJ consist of a superstructure, an elastic tension cord and a base compound.

The superstructure is made from a fibre-reinforced rubber mixture. The fibres are laid perpendicular to the direction of belt travel and stabilise the belt during dynamic operation.

The tension cord is a high modulus polyamide material embedded in a rubber compound and covers the entire width of the ribbed belt. The rib compound is characterised by high wear resistance and damping properties.

Advantages and Characteristics

- assembly is possible on fixed centres with no need for adjustment for belt tensioning
- easy assembly on the production line
- only one belt length may be usable for different drive configurations
- good shock load resistance due to high elasticity of belt
- maintenance-free
- easy assembly in service areas

Profiles and Belt Length Ranges

EPH	698 – 2155 mm
EPJ	280 – 2489 mm

Other sizes available on request

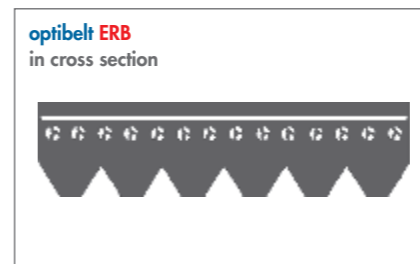

RIBBED BELT PULLEYS
standard range,
special pulleys on request

TIMING BELTS RUBBER

optibelt **OMEGA** – POWERFUL AND UNIVERSAL

High performance timing belt for extreme loads and synchronous power transmission

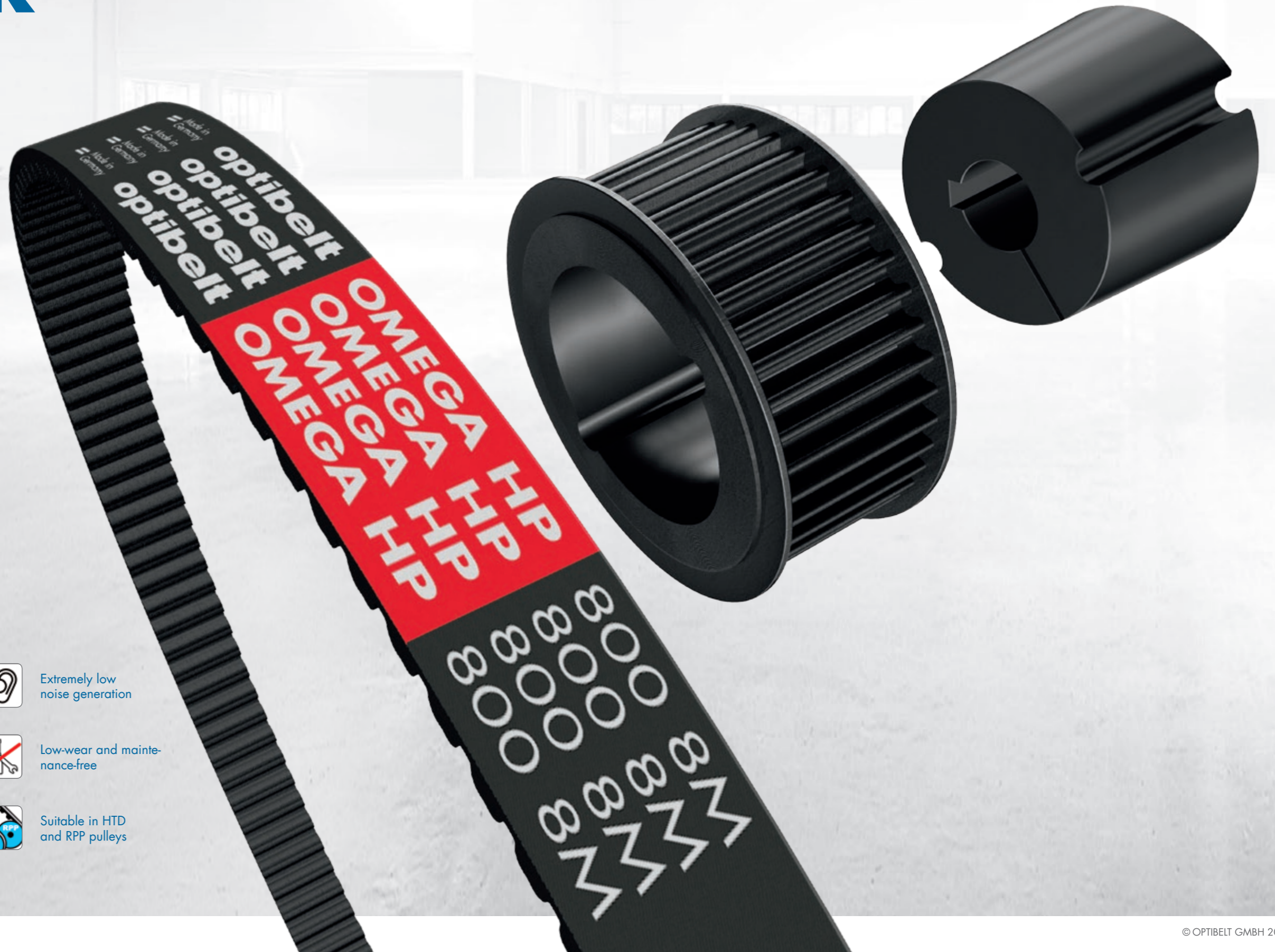

Temperature-resistant:
-30 °C to +100 °C



Extremely low
noise generation



Up to 2 times
power transmission*



Low-wear and mainte-
nance-free



Up to 18 times longer
service life*



Suitable in HTD
and RPP pulleys

* compared to standard timing belts

MASTERY OF THE DRIVE

TIMING BELTS OF THE optibelt OMEGA SERIES ARE OPTIMISED FOR USE IN SYNCHRONOUS POWER AND POSITIONING DRIVES.

Since their geometry has been matched to the common rounded pulleys, they are not only universally applicable, but also work maintenance-free without speed loss and with a constant transmission ratio, while at the same time running very quietly. While the **optibelt OMEGA** standard belt meets medium power requirements for slow and fast running drives, the **optibelt OMEGA HP** is the best choice for extremely heavily loaded, fast running drives. It is not only narrower, which reduces the bearing load and further reduces material costs for the drive implementation, but also achieves a performance level that is up to 150 percent higher than that of a standard belt in a direct comparison with it.

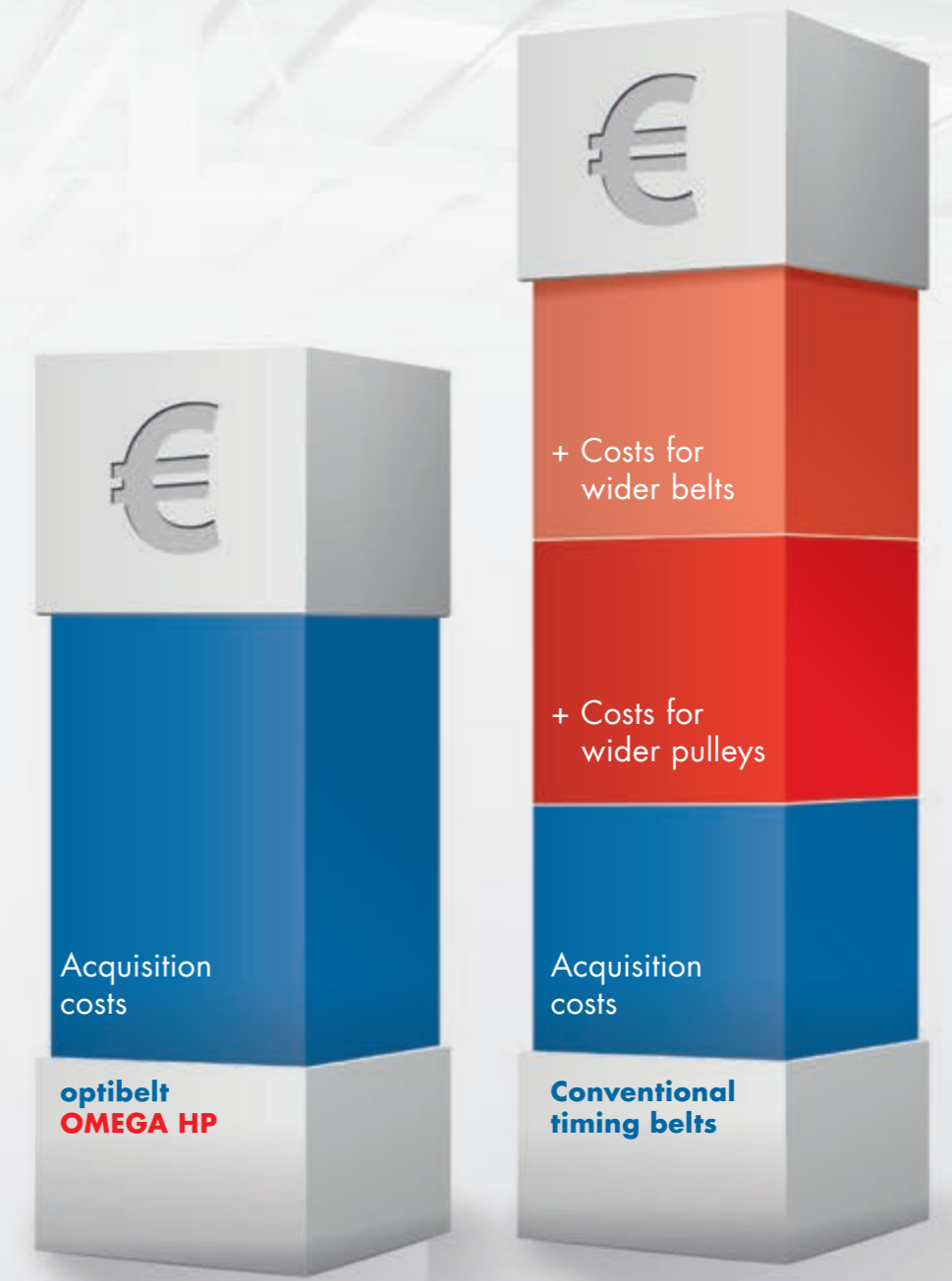
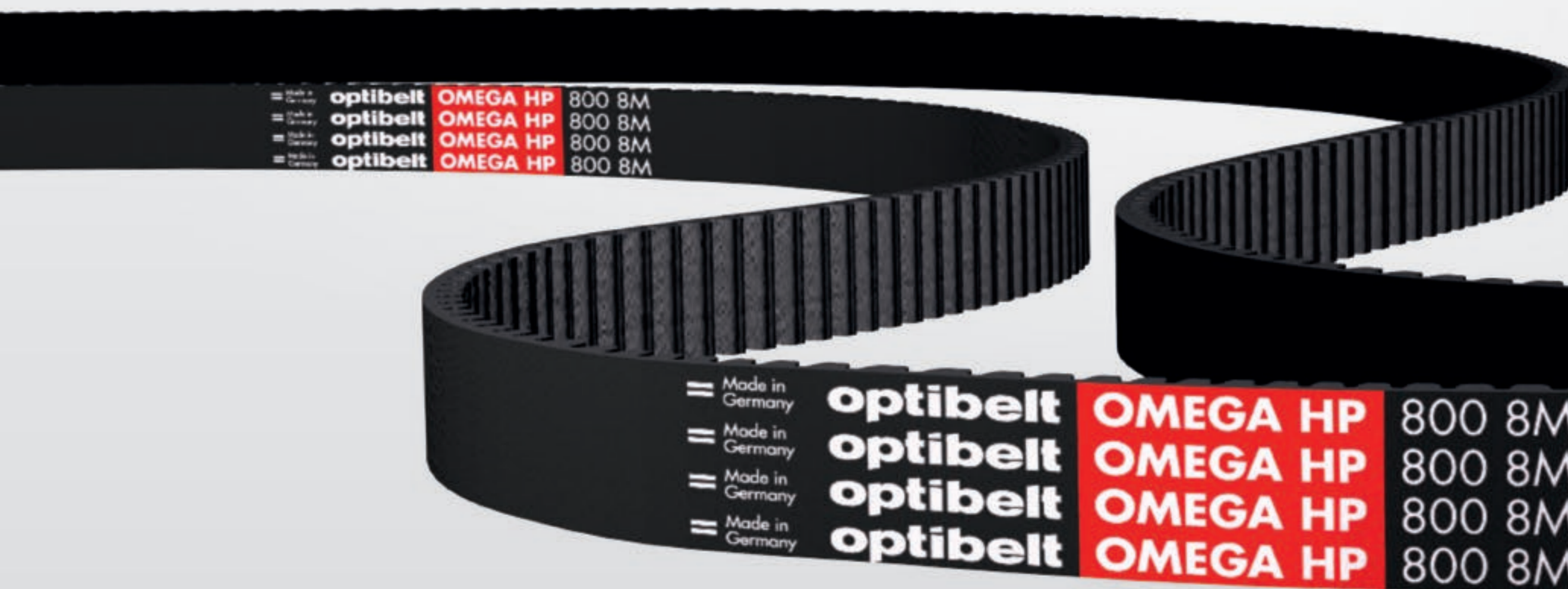

OMEGA 2IN1

PERFECT FIT WITH HTD AND RPP

OPTIMAL COMPATIBILITY

The enhanced profile of the **optibelt OMEGA 2in1** fits perfectly with HTD and RPP drive pulleys with 3, 5, 8 and 14 mm gaps. The **optibelt OMEGA 2in1** is the logical further development of round and curved tooth profiles. With an efficiency of 98 %, the **optibelt OMEGA 2in1** combines maximum economy with optimum power transmission. Its special profile is compatible with HTD and RPP drive pulleys. That is: One drive belt covers both pulley types perfectly – without any double stockholding. And thanks to the special tooth profile, it is audibly quieter than other timing belts.

THE PROFILE MAKES THE DIFFERENCE

Thanks to the special tooth form of the **optibelt OMEGA 2in1**, air can escape laterally from the drive pulleys. Contact with the drive pulley is virtually frictionless and noiseless.

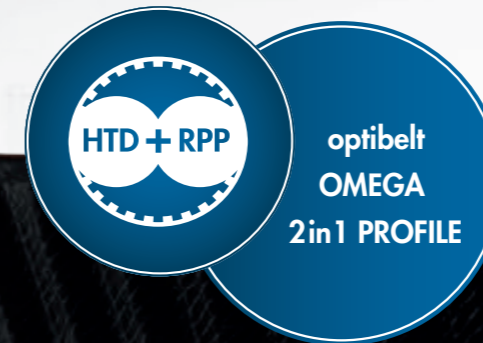

Reduced noise level due to special Omega tooth shape



Efficiency up to 98 %



Temperature-resistant:
-30 °C to +100 °C



Maintenance-free



For use in HTD
and RPP pulleys



No double stockholding

optibelt OMEGA HP

HIGH PERFORMANCE CHLOROPRENE TIMING BELTS

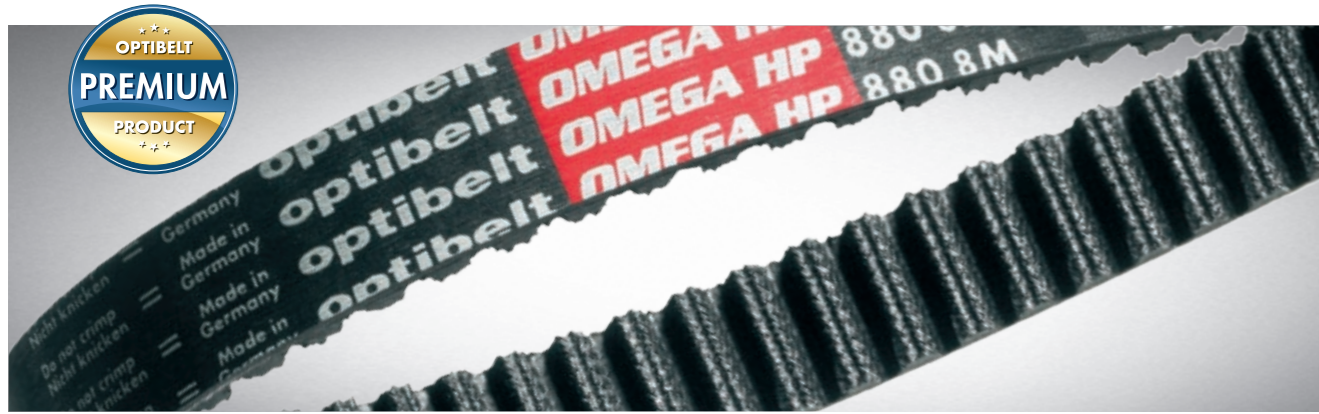

The **optibelt OMEGA HP** high performance timing belt was especially developed for heavily loaded, high speed drives. Improved materials and highly developed process engineering form the basis for this very high performance level.

For every power transmission requirement there is an appropriate belt section. Faster, stronger, more compact – that's how the **optibelt OMEGA HP** presents itself. A timing belt to meet the highest demands.

Advantages and Characteristics

- glass cord
- suitable for low and high speed, high dynamic load drives
- shear-resistant fabric with minimised wear and friction
- up to 2 times the power transmission capacity of the **optibelt OMEGA** standard

Profiles and Belt Length Ranges

2M HP	74 – 1224 mm
3M HP	111 – 1692 mm
5M HP	180 – 2525 mm
8M HP	288 – 3600 mm
14M HP	966 – 4578 mm

D8M HP 1120 – 3600 mm

Other profiles and dimensions on request

optibelt OMEGA HP in cross section



optibelt ZRS BELT PULLEYS

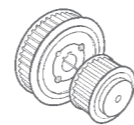

optibelt OMEGA timing belts run in standard HTD and RPP pulleys



HTD / RPP

optibelt OMEGA HL

HIGH PERFORMANCE CHLOROPRENE TIMING BELTS



On drives with a low belt speed, **optibelt OMEGA HL** timing belts surpass the capacity of **optibelt OMEGA HP** by up to 15 %. In addition, the design was optimised so that the **optibelt OMEGA HL** is much more suitable for shock loaded drives with fluctuating loads.

When used for new drive designs in these types of application, the **optibelt OMEGA HL** achieves the highest possible functional reliability in combination with optimum efficiency.

Advantages and Characteristics

- reinforced glass cord
- optimised absorption of shock loading
- highly resistant to dynamic loading
- very low elongation
- up to 15% more power than **optibelt OMEGA HP**

Profiles and Belt Length Ranges

8M HL	288 – 3600 mm
14M HL	966 – 4578 mm

Other profiles and dimensions on request

optibelt OMEGA HL in cross section

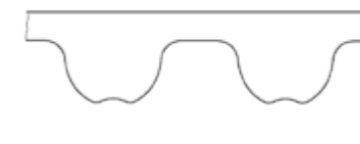

optibelt ZRS BELT PULLEYS

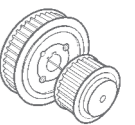

optibelt OMEGA timing belts run in standard HTD and RPP pulleys



HTD / RPP

optibelt OMEGA

CHLOROPRENE TIMING BELTS

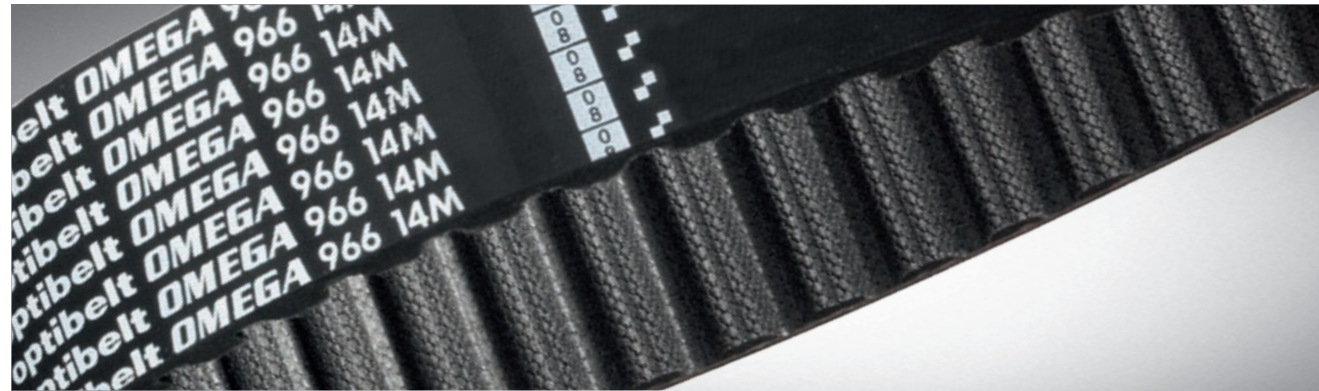

The **optibelt OMEGA** timing belt has the same performance level as the established **optibelt HTD** timing belt and supersedes it. The **optibelt OMEGA** is best for medium performance drives in all speed ranges without heavy shock loading.

Double-sided timing belts for drives with reversible speed can be delivered with HTD profiles.

optibelt OMEGA timing belts set standards for synchronous power transmission and positioning drives.

Advantages and Characteristics

- glass cord
- synchronous speed
- highest precision
- perceptibly lower noise level due to the **optibelt OMEGA** tooth profile
- maintenance-free
- temperature-resistant from -30 °C to +100 °C
- up to 98% efficiency

Profiles and Belt Length Ranges

- 2M 74 – 1224 mm
- 3M 111 – 1863 mm
- 5M 120 – 2525 mm
- 8M 288 – 4400 mm
- 14M 966 – 4578 mm

D8M 1120 – 3600 mm

Other profiles and dimensions on request

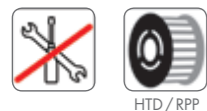
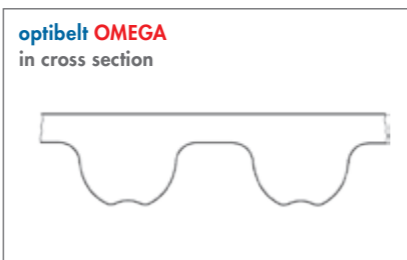

optibelt OMEGA FAN POWER

HIGH PERFORMANCE CHLOROPRENE TIMING BELTS



The requirements placed upon fan drives in the oil industry are high. The following product characteristics are expected: long service life, maintenance-free, high level of power transmission and anti-static behaviour in accordance with ISO 9563, non-sensitive to external influences such as temperature fluctuations and moisture.

The special tooth form and the use of particularly resistant materials ensure that **optibelt OMEGA FAN POWER** fulfills these fan drive requirements without compromise.

Advantages and Characteristics

- glass cord
- anti-static in accordance with ISO 9563
- optimised for low tooth meshing wear
- long service life
- maintenance-free
- high efficiency
- constant flow of air thanks to synchronous operation
- resistant to external influences such as variations in temperature and moisture

Profiles and Belt Length Ranges

- 8M FP 960 – 3048 mm
- 14M FP 1400 – 4578 mm

Other dimensions on request

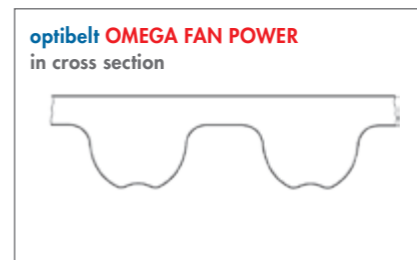

optibelt STD

CHLOROPRENE TIMING BELTS

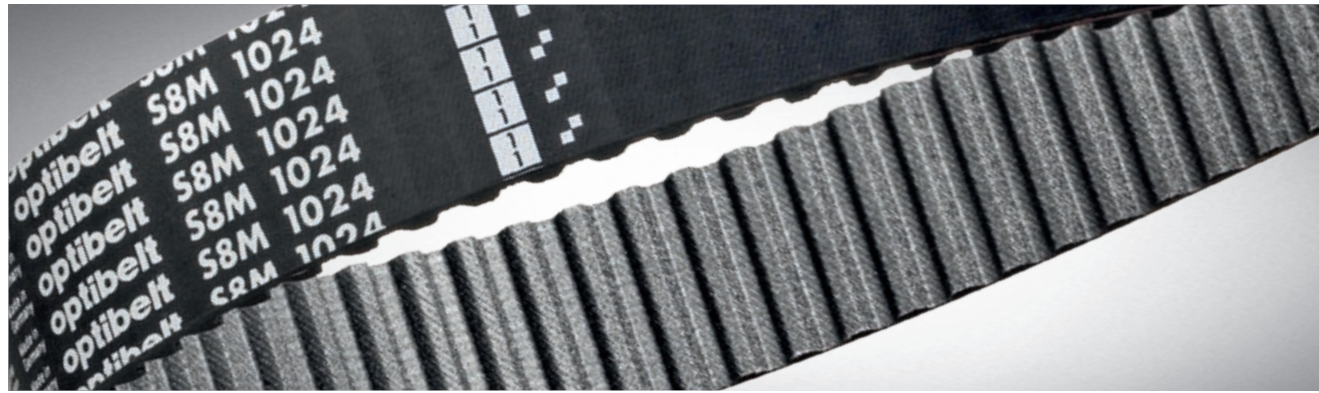

optibelt STD timing belts have semi-circular teeth for special shear strength.

The timing belt tooth geometry combined with the belt structure leads to even load distribution and optimised engagement of the timing belt pulleys.

optibelt STD also available in HP or HL quality.

Advantages and Characteristics

- for existing drives with STD profile
- noise level comparable to optibelt OMEGA profile
- interchangeability of the belt for existing pulleys
- for universal application
- ability to run in existing pulleys without loss of performance
- maintenance-free
- temperature-resistant from -30 °C to +100 °C

Profiles and Belt Length Ranges

- S3M 120 – 633 mm
- S5M 255 – 2000 mm
- S8M 440 – 3200 mm
- S14M 1400 – 5012 mm

Profiles and dimensions on request

optibelt STD in cross section

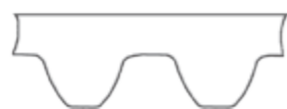

optibelt ZRS
TIMING BELT PULLEYS
standard STD timing belt pulleys

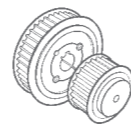

optibelt OMEGA double-sided

TIMING BELTS MADE OF CHLOROPRENE

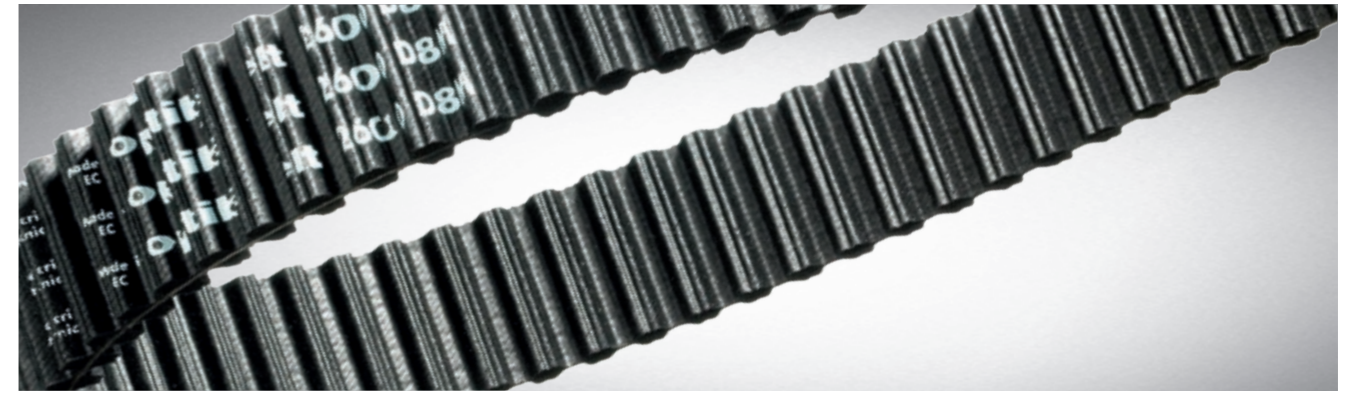

The double-sided optibelt OMEGA belt replaces the double-sided optibelt HTD timing belt and delivers high performance levels.

The optibelt OMEGA timing belt meets today average power requirements for slow to fast running drives without special shock loading.

Advantages and Characteristics

- high precision, synchronous running
- reduced noise levels
- maintenance-free
- up to 98 % efficiency

Profiles and Belt Length Ranges

- D2M on request
- D3M on request
- D5M 1000 – 2525 mm
- D8M 1000 – 3280 mm
- D14M 1000 – 3150 mm

Further dimensions available on request

optibelt OMEGA double-sided in cross section



TIMING BELT PULLEYS
optibelt OMEGA
timing belts run in standard HTD and RPP pulleys

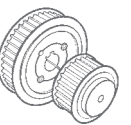

HTD / RPP

optibelt OMEGA HP double-sided

HIGH PERFORMANCE CHLOROPRENE TIMING BELTS

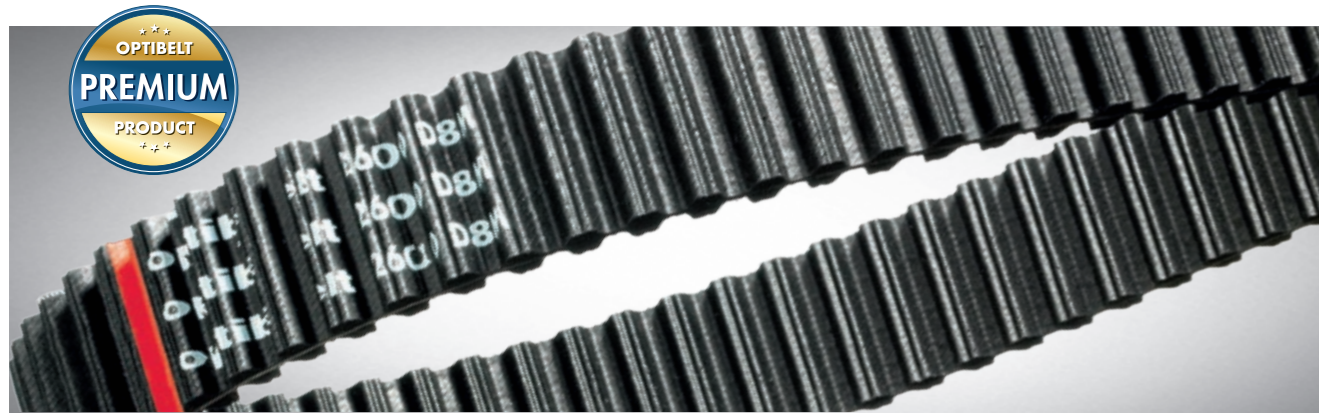

The double-toothed **optibelt OMEGA HP** high performance timing belt was especially developed for heavily loaded, high speed drives.

Improved materials and highly developed process engineering are the basis for this very high performance level.

In contrast to double-sided **optibelt OMEGA** timing belts, the **optibelt OMEGA HP** with improved performance achieves clear cost savings in new designs of multi-pulley drives due to significantly smaller **optibelt ZRS** timing belt pulleys.

In the case of existing, but overloaded multi-pulley drives with RPP, HTD or **optibelt OMEGA** timing belts of basic design, **optibelt OMEGA HP** high performance timing belts are also suitable as problem-solvers that have the potential to greatly increase short operating times.

Faster, stronger, more compact – that is how the new double-sided **optibelt OMEGA HP** presents itself.

A timing belt to meet the highest demands.



Advantages and Characteristics

- suitable for low and high speed, dynamically heavily loaded drives with speed reversion
- approximately double the power transfer compared to **optibelt OMEGA** timing belts in the basic design
- broad application spectrum
- for HTD and RPP timing belt pulleys

Profiles and Belt Length Ranges

8M FP 1120 – 3600 mm

Other sizes available on request

optibelt OMEGA HP double-sided in cross section

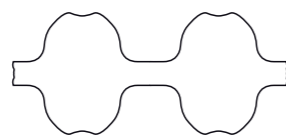

optibelt ZRS TIMING BELT PULLEYS

optibelt OMEGA timing belts run in standard HTD and RPP pulleys

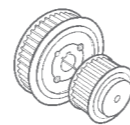

optibelt OMEGA HP LINEAR

OPEN-ENDED HIGH PERFORMANCE TIMING BELTS

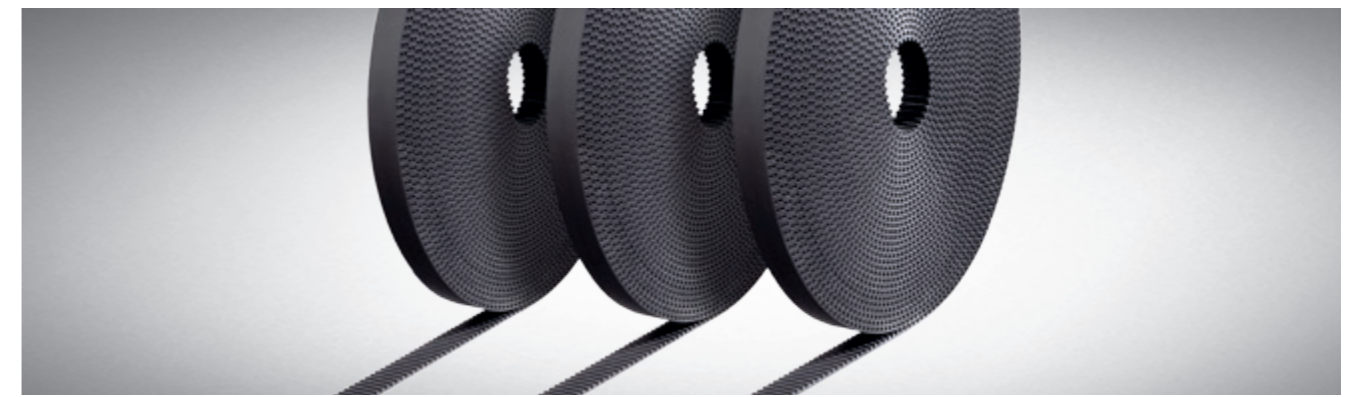

optibelt OMEGA HP LINEAR timing belts made of chloroprene are open-ended timing belts with glass cord made from spiral cut coils.

Advantages and Characteristics

- high tensile strength
- low stretch
- high positioning accuracy
- maintenance-free

Sections and Belt Length Ranges

3M HP 6 – 15 mm
5M HP 10 – 25 mm
8M HP 10 – 30 mm

Standard roll length 30 m

optibelt OMEGA HP LINEAR in cross section



TIMING BELT PULLEYS

optibelt OMEGA timing belts run in standard HTD and RPP pulleys

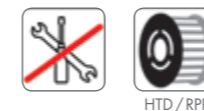
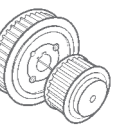

optibelt OMEGA LINEAR

TIMING BELTS



optibelt OMEGA LINEAR timing belts made of chloroprene with glass cord are open-ended timing belts made from spiral cut coils.

Advantages and Characteristics

- high tensile strength
- low stretch
- high positioning accuracy
- maintenance-free

Profiles and Belt Length Ranges

3M	9 mm
5M	10 – 25 mm
8M	10 – 25 mm

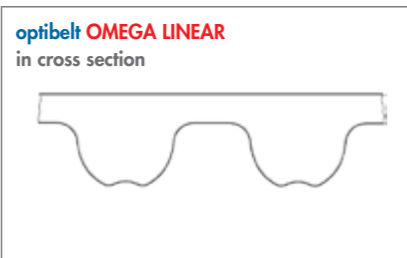

TIMING BELT PULLEYS
optibelt OMEGA
 timing belts run in standard HTD and RPP pulleys



optibelt STD LINEAR

OPEN-ENDED HIGH PERFORMANCE TIMING BELTS



optibelt STD LINEAR timing belts made of chloroprene with glass cord are open-ended timing belts made from spiral cut coils.

Advantages and Characteristics

- high tensile strength
- low stretch
- high positioning accuracy
- quieter than **optibelt HTD**, **optibelt ZR** and timing belts made of polyurethane
- maximum angular misalignment 0.67° (depending on width)
- maintenance-free
- for medium to high loading
- with reference to ISO 13050

Profiles and Belt Length Ranges

S5M HP	10 – 25 mm
S8M HP	10 – 25 mm

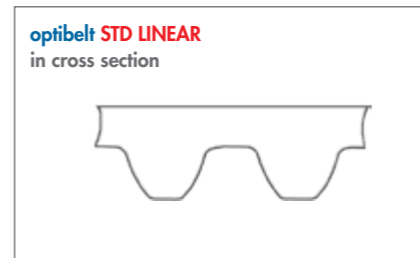

optibelt ZRS
TIMING BELT PULLEYS
 standard STD timing belt pulleys

POLYURETHANE TIMING BELTS

optibelt **DELTA CHAIN Carbon** – POWERFUL INNOVATION

Optibelt is setting new standards in drive technology with the **optibelt DELTA CHAIN Carbon** with exceptional tensile strength and durability. Designed for high torques, this innovative high performance timing belt with carbon cord delivers optimum performance even under extreme loads and is therefore an optimum alternative to drives with roller chains.



GERMAN
DESIGN
AWARD
2016



For drives with
high torque



Innovative special fabric with
optimised tooth form



Tear and impact-resistant
for heavy-duty use



2*P Double
power transmission

optibelt DELTA CHAIN Carbon 896 8M 21
optibelt DELTA CHAIN Carbon 896 8M 21
optibelt DELTA CHAIN Carbon 896 8M 21



optibelt DELTA CHAIN Carbon

HIGH PERFORMANCE POLYURETHANE TIMING BELTS



Highly dynamic, tough, tear-resistant, durable, and brand new:

The **optibelt DELTA CHAIN** with carbon cord is the perfect alternative to drives with roller chains. Designed for high torque, it delivers the best performance values even under extreme conditions and high loads.

Our innovation studies showed in extensive tests that a performance increase of up to 100% over comparable high performance synchronous rubber belts is possible.

Advantages and Characteristics

- optimised tooth form
- unmatched shock resistance
- temperature resistance
- double power transmission
- newly developed special fabric
- high reliability

A NEW MATERIAL GENERATION

- tear-resistant for heavy demand
- durable
- for drives with high torque

Dimensions

- 8M DC 640 – 4480 mm
- 14M DC on request

Other sizes available on request



optibelt DELTA CHAIN Carbon in cross section



optibelt ZRS TIMING BELT PULLEYS

optibelt DELTA CHAIN Carbon timing belts run in standard ZRS DC, CTD and PC pulleys

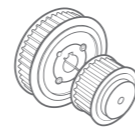

CTD/PC

optibelt ALPHA POWER

HIGH PERFORMANCE POLYURETHANE TIMING BELTS



The powerful **optibelt ALPHA POWER** timing belts are the result of consistent further development. The wide-ranging experience gained with ALPHA standard timing belts is now reflected in this belt generation. Made with a new, more resistant and more durable polyurethane compound, the performance of this generation is up to 30% higher than that of the previous standard belt.

By enabling a more compact drive design, the **optibelt ALPHA POWER** cuts costs, starting with the purchase costs for new belts and pulleys. The optimised interplay of the polyurethane and steel cord components guarantees the **optibelt ALPHA POWER** an extremely economical solution for a wide range of applications.

Advantages and Characteristics

- higher power transfer – up to 30% in comparison with conventional standard polyurethane timing belts
- very accurate pitch and low tolerances
- strong attachment of polyurethane to tension cord
- variable position of the tolerance zone, for fixed centre distances, for example
- tension cords: steel, highly flexible steel, stainless steel

Profiles and Belt Length Ranges

T2.5	107.5 – 950 mm
T5	165 – 1440 mm
T10	260 – 2250 mm
AT5	200 – 1500 mm
AT10	500 – 1940 mm
DT5	300 – 1100 mm
DT10	600 – 1880 mm

Other dimensions on request

optibelt ALPHA POWER in cross section



optibelt ZRS TIMING BELT PULLEYS

all standard pulleys, special pulleys on request

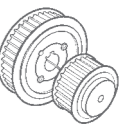

optibelt ALPHA TORQUE

POLYURETHANE TIMING BELTS

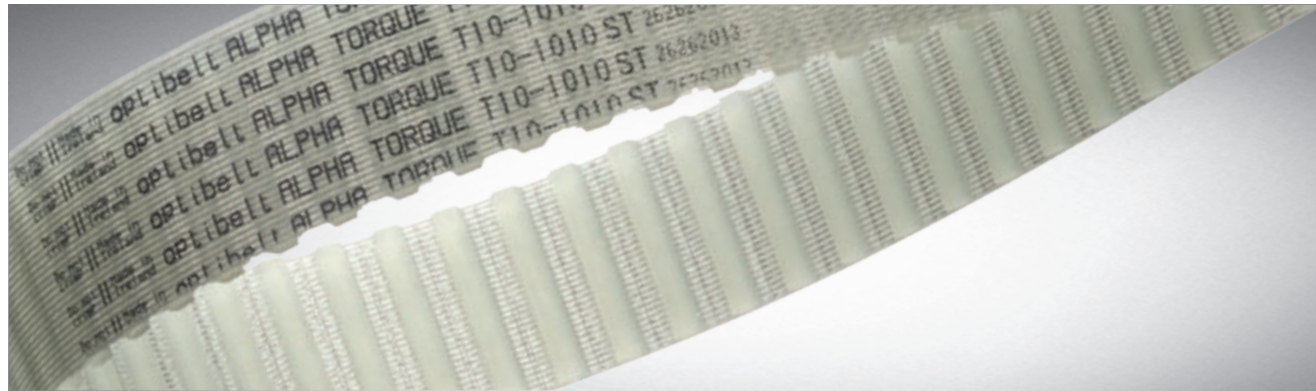

The **optibelt ALPHA TORQUE** is extremely abrasion-resistant; oil resistance is a standard feature as well as some resistance to acids and alkaline solutions.

Low-stretch steel cords with high flexibility are used.

Advantages and Characteristics

- useful sleeve widths of up to 380 mm
- unlimited choice of colours on request
- position of tolerance field variable, e.g. for fixed drive centre distances
- tension cords: steel, highly flexible steel, stainless steel, aramid, polyester, Vectran®

Profiles and Belt Length Ranges

T2.5	107.5 – 950 mm
T5	165 – 1440 mm
T10	260 – 2250 mm
AT5	200 – 1500 mm
AT10	500 – 1940 mm
DT5	300 – 1100 mm
DT10	260 – 1880 mm
MXL	2.40 – 32.00 in
XL	6.00 – 67.00 in
L	12.38 – 60.00 in

Other sizes available on request

optibelt ALPHA TORQUE in cross section



optibelt ZRS TIMING BELT PULLEYS

all standard pulleys, special pulleys on request

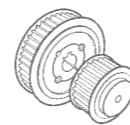

optibelt ALPHA FLEX

POLYURETHANE TIMING BELTS



The **optibelt ALPHA FLEX** timing belt is manufactured as an endless spirally-wound steel tension cord without any breaks in the tensile reinforcement. This ideal combination of extremely strong tension cords and the use of polyurethane makes these timing belts suitable for universal application in areas where high performance must be transmitted in systems with large centre distances.

The principal uses are drive systems requiring very long belts, such as very long conveyors, or in operational situations with demanding performance requirements.

Advantages and Characteristics

- length range can be manufactured according to gradations in pitch
- production widths 100 mm and 150 mm
- optionally with polyamide fabric on the teeth
- direct welding on of cams and cleats possible
- with options of highly flexible or stainless steel tension cords
- available with S or Z cord twist
- double-sided profiles for DT5, DT10, DAT5, DAT10, D5M, D8M available

Profiles and Belt Length Ranges

5	500 – 24000 mm
T10	1500 – 24000 mm
T20	1500 – 24000 mm
AT5	1500 – 24000 mm
AT10	1500 – 24000 mm
AT20	1500 – 24000 mm
5M	1500 – 24000 mm
8M	500 – 24000 mm
14M	1500 – 24000 mm

Length > 24000 mm available on request

optibelt ALPHA FLEX in cross section



optibelt ZRS TIMING BELT PULLEYS

all standard pulleys, special pulleys on request

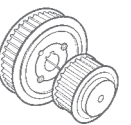

optibelt ALPHA LINEAR

POLYURETHANE TIMING BELTS

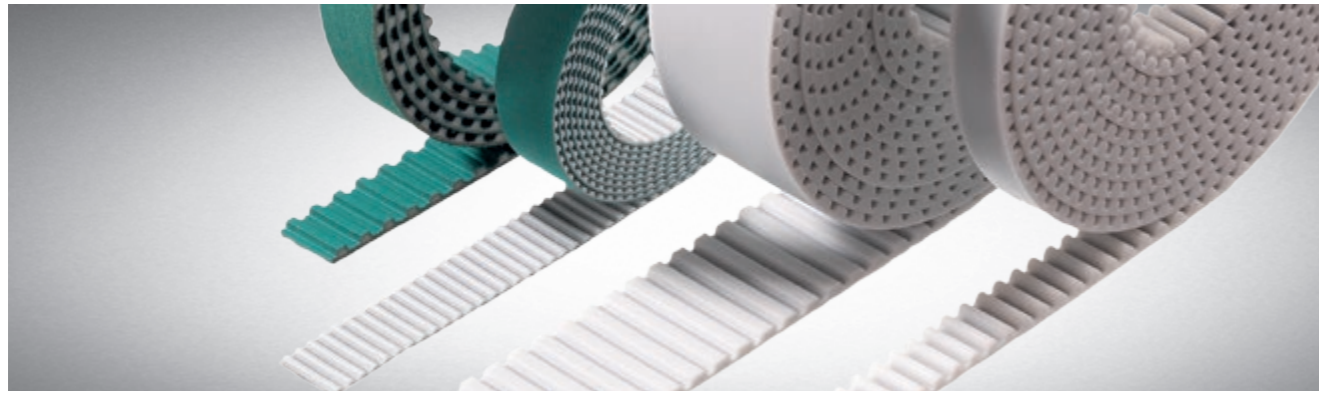

The **optibelt ALPHA LINEAR** timing belt is predominantly used in linear drive systems as a large-dimension open-ended belt. The aramid or steel tension cord has extremely low elasticity. The large range of profiles and lengths makes a host of drive solutions possible.

The thermoplastic polyurethane surface is ideal for applying various coatings and welding on cams and lugs.

The main areas of application for the **optibelt ALPHA LINEAR** are found in the field of transport and conveyor technology as well as in the areas of processing and control technology.

Advantages and Characteristics

- high tensile strength with low elongation
- high-precision positioning
- tension cords: steel, highly flexible steel, stainless steel, aramid
- with options of reinforced belt back, T2, yellow PU foam and APL plus
- ATL version timing belts for linear drives
- polyamide fabric supports on tooth side and/or belt top surface available
- PU also available with FDA approval for food contact
- optional colours available

Profiles

XL; L; H; XH;
T5; T10; T20;
AT5; AT10; AT20;
ATL5; ATL10; ATL20;
5M; 8M; 14M; 14ML;
F2; F2.5; F3; FL3

Roll Length

50 m or 100 m
> 100 m available on request

optibelt ALPHA LINEAR
in cross section



optibelt ZRS TIMING BELT PULLEYS

all standard pulleys,
special pulleys on request

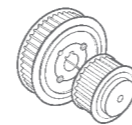

optibelt ALPHA SRP

TIMING BELTS

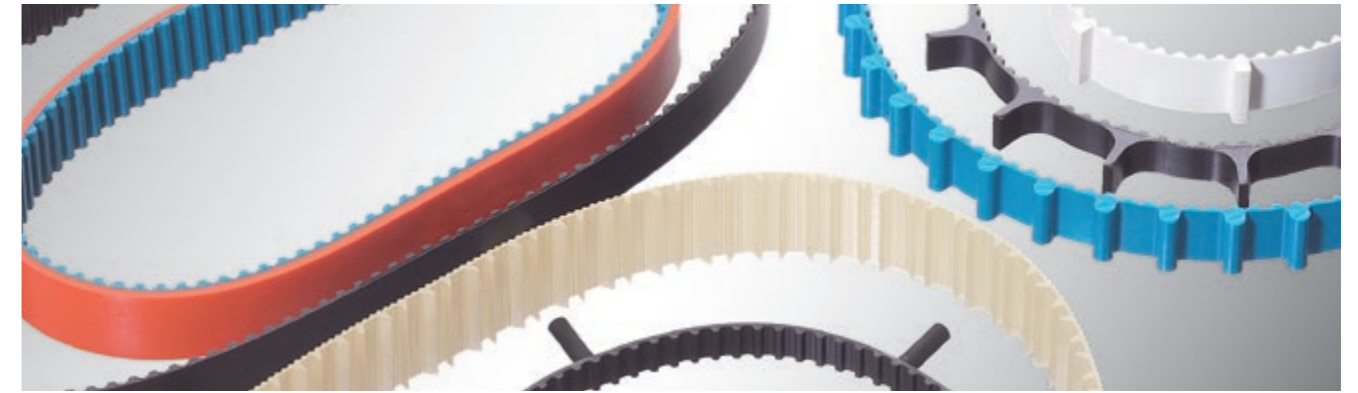

The **optibelt ALPHA SRP** timing belt with cast cleats and coatings is manufactured in a single production step and used in conveying systems.

The polyurethane is cast between the core mould and the special outer mould with correspondingly increased internal diameter or special outer moulds with the desired contour for the cleats.

By rotating the inner and outer moulds around the central axis, a Shore hardness that differs from that of the teeth can be cast using a centrifugal casting process.

Advantages and Characteristics

- high number of cleats in a very small space
- strong connection between cleat and base belt
- coating with no butt joints, no binding in direction of travel
- production in moulds allows small, coated belts to be manufactured
- reproducible high precision
- strong connection between cleat/coating and base belt due to consistent cross-linking
- finely formed cleat geometry thanks to liquid cast polyurethane

Dimensions

T2.5; T5; T10; T20; AT5; AT10; AT20;
MXL; XL; L

Other sizes available on request

optibelt ALPHA SRP
in cross section

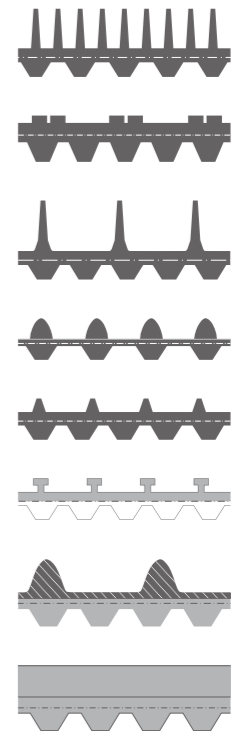

TIMING BELT PULLEYS

all standard pulleys,
special pulleys on request.

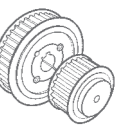

SPECIAL BELTS

optibelt **OPTIMAT** – THE SPECIALIST FOR PARTICULAR CASES

Special thermoplastic polyurethane belts have been developed in terms of their shape and further processing to make them suitable for special applications. Whether as round belts in open-ended metre ware, as flexible variants that can be made shorter or with special perforations: no conveying task is too complex for these specialists.



Particularly low elongation



Ideal for use in long conveyors



Available in different colour variations

optibelt RR / RR Plus

ROUND BELTS MADE OF THERMOPLASTIC POLYURETHANE

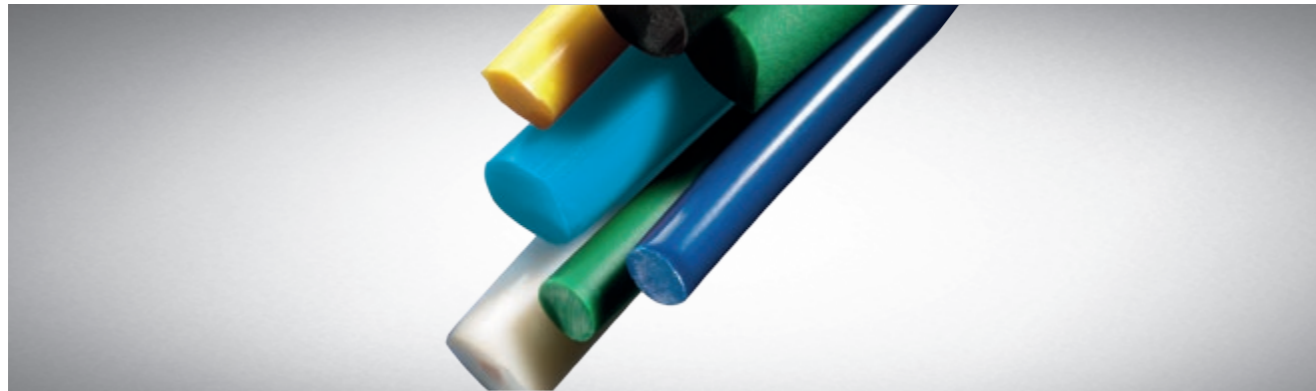

Optibelt round belts consist of high-quality materials, which are manufactured by special manufacturing processes as open-ended metre ware in different diameters.

The **optibelt RR Plus** version of the round belt additionally incorporates a polyester tension cord. The round section belts with tension cords are particularly low-stretch and therefore especially useful when used in long conveyors.

Advantages and Characteristics

- welding takes place on site. This also applies to the **optibelt RR Plus** version
- no disassembly of the drive/shafts
- quick rectification of breakdowns
- short downtimes
- easy to store (supplied in rolls)
- immediate availability
- wide variety of design options, since any length can be produced
- favourable coefficient of friction
- good slip resistance for conveying goods
- good abrasion and wear resistance
- high elasticity, good damping
- high tensile strength
- colour-fast
- resistant to greases, oils and numerous chemicals
- UV and ozone resistant
- the **optibelt RR Plus** version is particularly low-stretch

Roll Lengths

2	200 m	8*	100 m
3	200 m	10*	100 m
4	200 m	12*	50 m
5	200 m	15*	50 m
6*	100 m	18	30 m
7*	100 m		

* Also available with tension cord

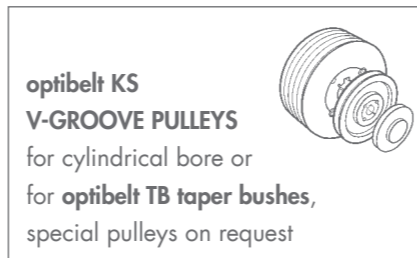
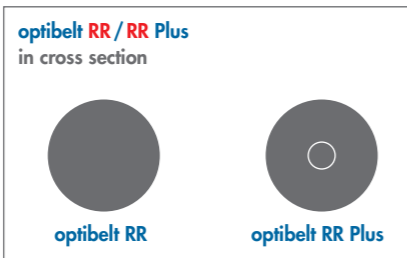

optibelt HRR

ROUND BELTS MADE OF THERMOPLASTIC POLYURETHANE



Optibelt hollow round belts consist of high-quality materials, which are manufactured by special manufacturing processes as open-ended metre ware in different diameters.

optibelt HRR belts are particularly suitable for use in light drive systems and conveyor systems, especially for small pulley diameters.

Advantages and Characteristics

- for use with small pulley diameters (**75 SHORE A**)
- short downtimes
- for use with medium drives, for quick repairs (**85 SHORE A**)
- easy to store (supplied in rolls)
- immediate availability
- wide variety of design options, since any length can be produced
- favourable coefficient of friction
- good slip resistance for conveying goods
- good abrasion and wear resistance
- high elasticity, good damping
- high tensile strength
- colour-fast
- resistant to greases, oils and numerous chemicals
- UV and ozone resistant

75 SHORE A RED/SMOOTH	
DIAMETER	ROLL LENGTH ON SPOOL
4.8 mm	200
6.3 mm	100
8.0 mm	100
9.5 mm	100

Recomm. belt tension:

Welded	4...8 %
Nipple connector*	max. 3...6 %

85 SHORE A GREEN/ROUGH	
DIAMETER	ROLL LENGTH ON SPOOL
4.8 mm	200
6.3 mm	100

Recomm. belt tension:

Welded	4...8 %
Nipple connector*	max. 3...6 %

* Nipple connector not included in scope of delivery. Please order separately.

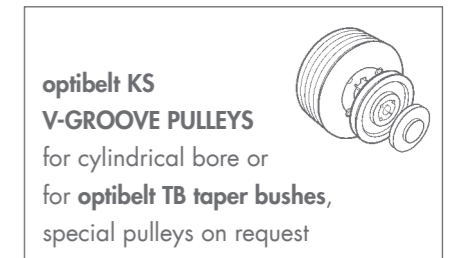
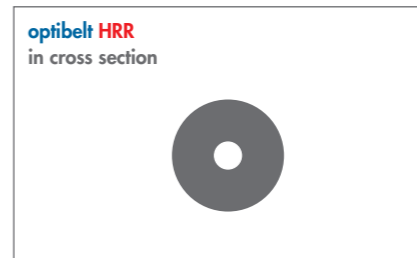

optibelt OPTIMAT OE / DK / FK / PKR

OPEN-ENDED V-BELTS – PUNCHED

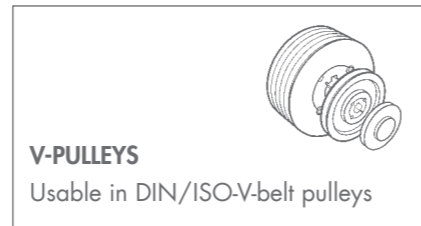
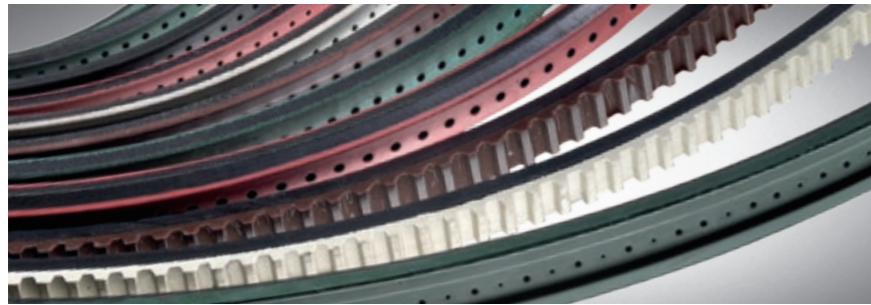

optibelt OPTIMAT OE / DK / FK

OPEN-ENDED V-BELTS
perforated, DIN 2216

SPECIAL VERSION

- available with black chloroprene cover belts
- electrically conductive (on request)

-  **OPTIMAT OE**
V-belts,
DIN 2216,
perforated
-  **OPTIMAT DK**
Double V-belts,
perforated
-  **OPTIMAT FK**
Conveyor belts,
perforated

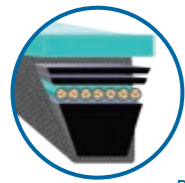

PKR 0

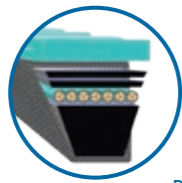

PKR 1

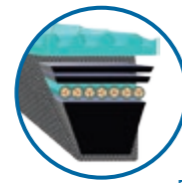

PKR 2

HEIGHT OF TOP SURFACE			
TYPE OF TOP SURFACE	STANDARD (mm)	MAX. (mm)	CLASSIFICATION (mm)
PKR 0	2	3	–
PKR 1*	3	3	10
PKR 2	3	–	–

optibelt OPTIMAT PKR

OPEN-ENDED V-BELTS

DIN 2216 with top surface

Profiles: Z/10, A/13, B/17, C/22, 25**, D/32**

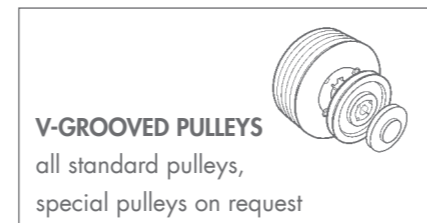

*Special versions are only available in fabrication lengths of 50 m +/- 10 %.

**The profile 25 and D/32 height of top surface is only available with 5 mm.



BELTS MADE TO MEASURE

Where performance is required in combination with customer-specific drive solutions, Optibelt delivers masterly solutions.



"For optimum performance."

Norbert, 42, foreman

INDUSTRY-SPECIFIC DRIVE SOLUTIONS



optibelt GREEN GARDEN FOR GARDEN APPLIANCES

Whether for coupling or uncoupling ride-on mowers or chopping and shredding garden waste: The professional drive solutions from **optibelt GREEN GARDEN** ensure maximum power transmission.



optibelt CONVEYOR POWER FOR ROLLER CONVEYOR BELTS

Developed specifically for the transport and logistics sector, the drive belts from the **optibelt CONVEYOR POWER** range are real all-rounders. Since they are specially designed for roller conveyor applications, they offer a maximum range of uses.



optibelt AGRO POWER FOR AGRICULTURAL MACHINERY

optibelt AGRO POWER ensures a good power connection with high performance at the same time. The drive belts run with low vibration and noise, even at high belt speeds.

CUSTOMISED DRIVE SOLUTIONS

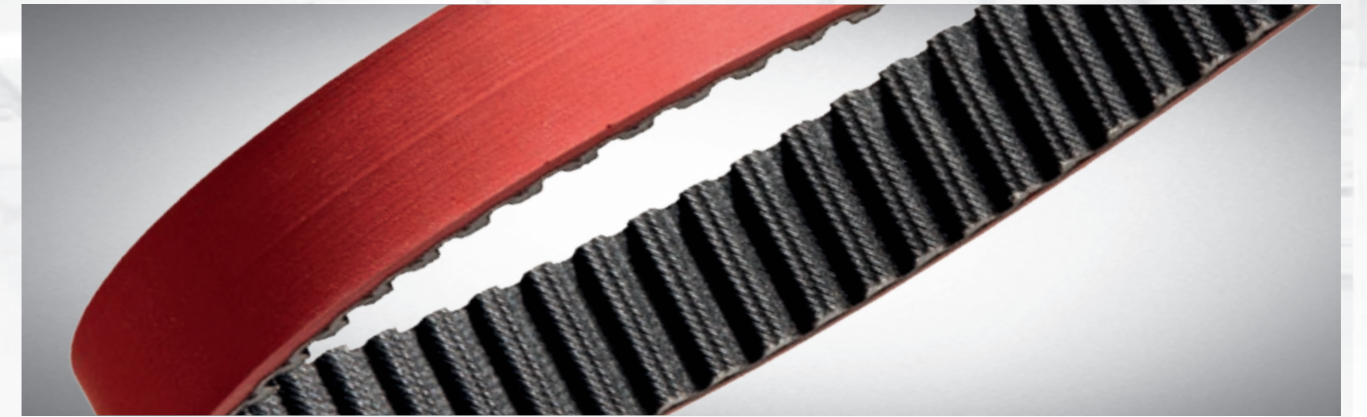

optibelt OMEGA SPECIAL
FOR USE IN PRINTING MACHINES

This seamless silicone-coated special timing belt is manufactured in just one production process. It is perfect for critical applications in printing presses as it is highly temperature and UV resistant.



optibelt ERB SPECIAL
FOR ESCALATORS AND WALKWAYS

This coated V-ribbed belt was developed in cooperation with a manufacturer of escalators and walkways. It moves the powerful drive of a moving staircase and guarantees smooth and almost noiseless practical use.

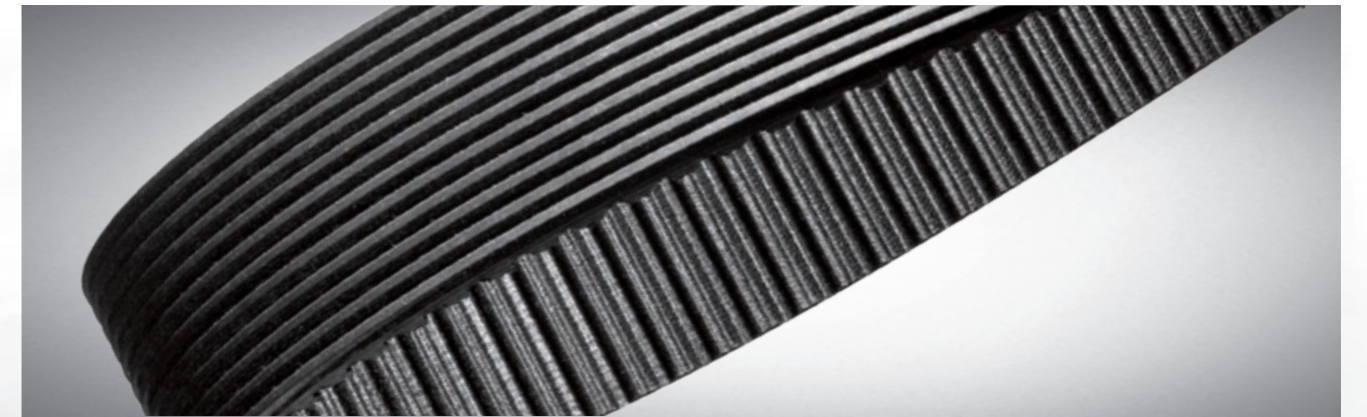

optibelt OMEGA RB
FOR MILL DRIVES

This maintenance-free timing belt with additional PK V-ribbed belt on the rear side of the belt is the first choice for mill drives. It is extremely wear-resistant and is also suitable for mills in which the direction of the drive pulley on the rear can be reversed.

METAL



DRIVE PULLEYS

Drive pulleys for force-locking or form-fit connections in all common profiles and materials – V-grooved pulleys, V-ribbed pulleys, toothed pulleys and special pulleys for taper bushings and cylindrical bores

optibelt TB TAPER BUSHES

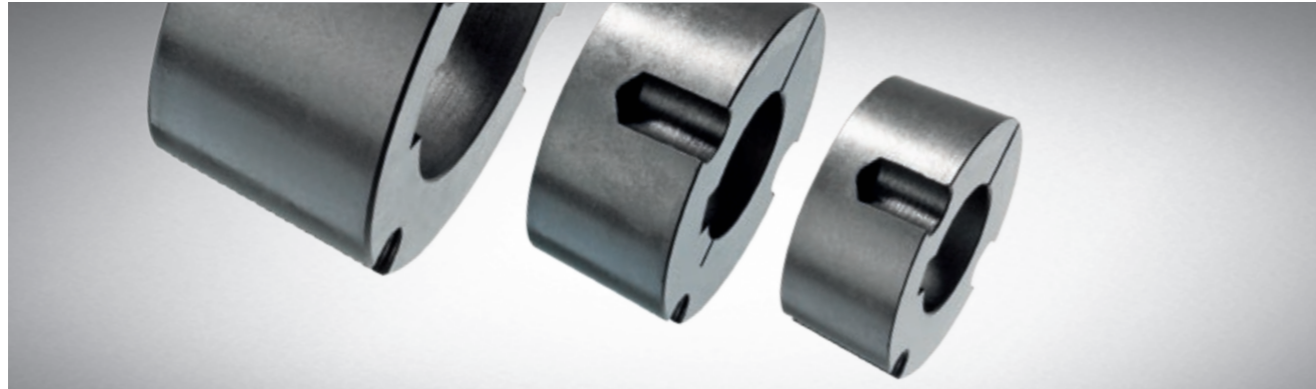

DIMENSIONS					
TAPER BUSHES	BORE DIAMETER				
1008	10–25 mm	1310	14–35 mm	3030	35– 75 mm
1108	10–28 mm	1610	14–42 mm	3525	35– 90 mm
1210	11–32 mm	1615	14–42 mm	3535	35– 90 mm
1215	11–32 mm	2012	14–50 mm	4040	40–100 mm
		2517	16–60 mm	4545	55–110 mm
		3020	25–75 mm	5050	70–125 mm

optibelt METAL ACCESSORIES

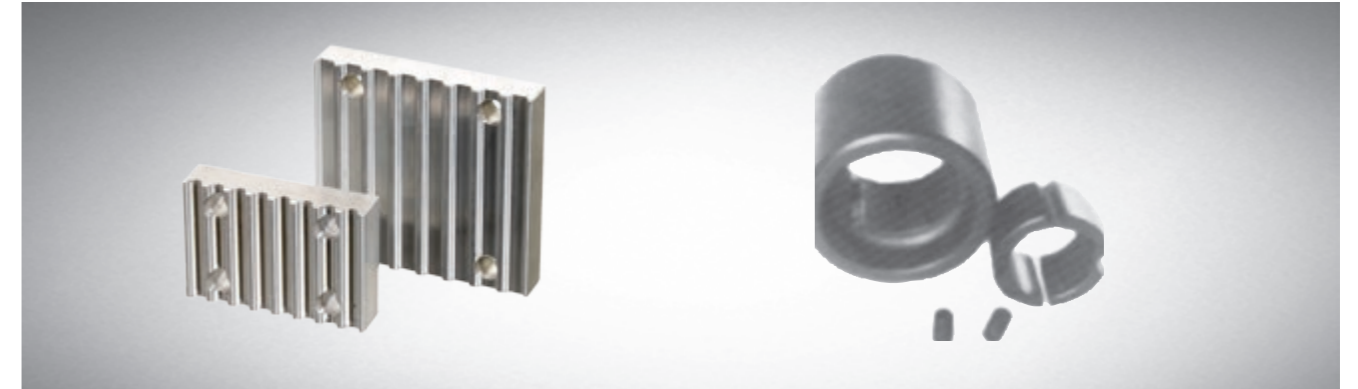

optibelt CP
Clamping plates

optibelt FS
Flat belt pulleys for taper bushes

optibelt CE CLAMPING BUSHINGS



DIMENSIONS					
DESIGNATION	BORE DIAMETER				
CE01	18–400 mm	CE05	20–200 mm	CE12	16– 60 mm
CE02 / CE03	6–100 mm	CE06	20–180 mm	CE13	15– 70 mm
CE04	20–180 mm	CE07	20–200 mm	CE14	24–260 mm
		CE08	25–200 mm		
		CE09	45–100 mm		
		CE10 / CE11	14– 60 mm		

PRODUCT & PRODUCTION ASSORTMENT

WE PROVIDE CUSTOMISED DRIVE SOLUTIONS

SPECIAL SOLUTIONS

In addition to a versatile standard product range, state-of-the-art CAD technology can also be used to meet special customer requirements with regard to tooth systems, such as ratchet and Hirth tothing, conical and elliptical tothing, combination tothing or elements such as multiple spline shafts and spline hubs.

TRANSMISSIONS AND ASSEMBLIES



SPUR GEARS AND HELICAL GEARS



SPROCKETS



RACKS



WORMS AND WORM GEARS



BEVEL GEARS



SPUR GEARS AND HELICAL GEARS



SPECIAL PULLEYS



SPECIAL TOOTH SYSTEMS



MADE-TO-MEASURE DRIVE

Whether complete assemblies and gears including maintenance-free belts or individual components such as toothed pulleys, gears and racks – in close contact with the customer, tailor-made individual solutions are created, even for complex applications – all from a single source.

SPECIAL DRIVES

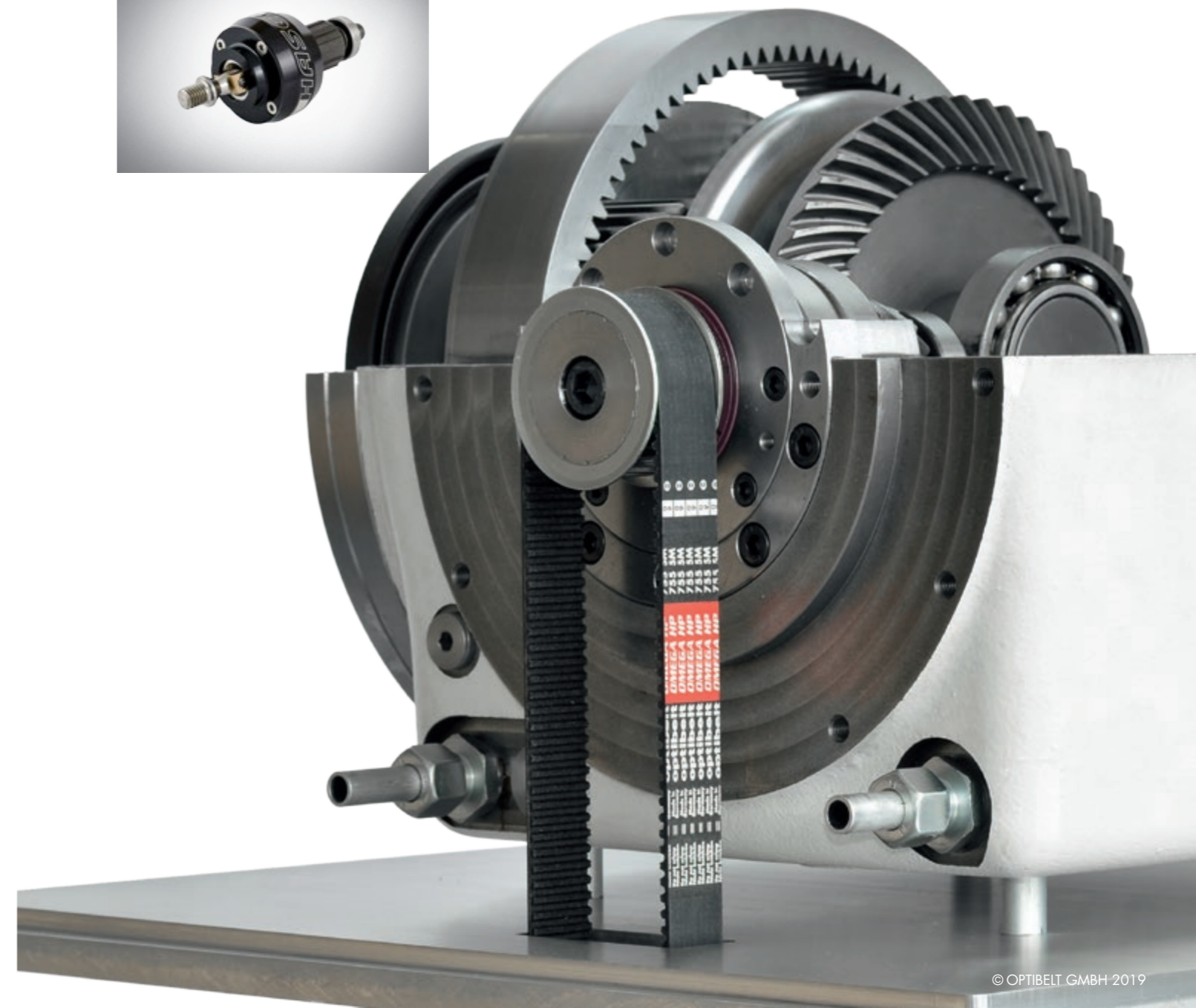

COUPLINGS

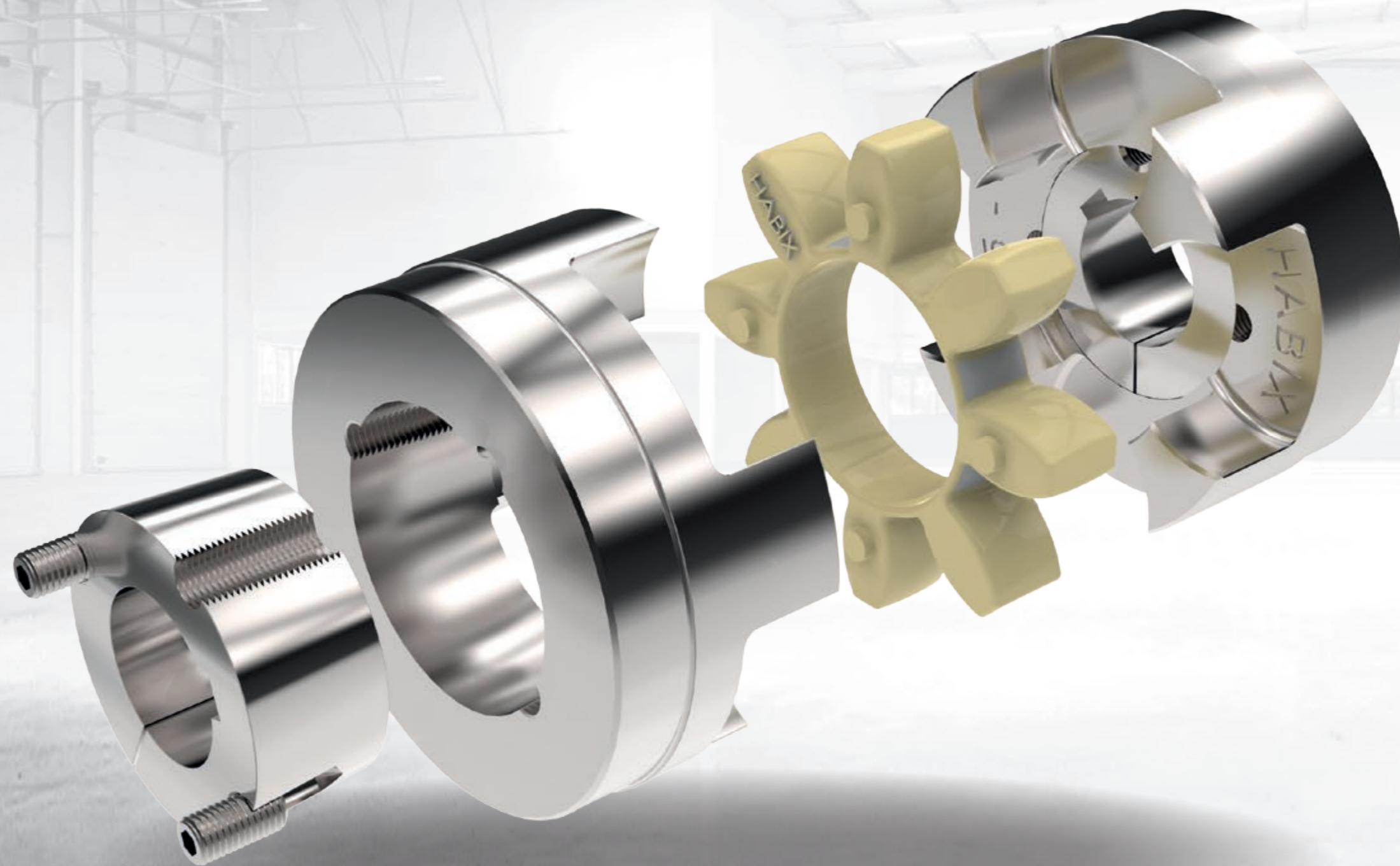

ELASTIC COUPLINGS

HABIX



- Fail-safe plug-in/jaw coupling with flexible element (star)
- Types: HWN, HWT
- Sizes: 15 – 90
- Standard applications with normal requirements regarding torque and damping capabilities

HADEFLEX



- Fail-safe plug-in/jaw coupling with flexible element (star)
- Types: XW (pre-drilled), TX (with taper bush), F
- Sizes: 24 – 260
- Standard applications with normal requirements regarding torque and damping capabilities

HRC



- Fail-safe encapsulated plug-in/jaw coupling with flexible element (star)
- Sizes: 70 – 280
- Applications with increased requirements regarding torque and damping capabilities

FLEX



- Highly flexible backlash-free tyre coupling
- Sizes: 40 – 250
- Applications with increased requirements for damping properties at low torques to be transmitted

ORPEX



- Fail-safe pin coupling with flexible elements
- Sizes: 105 – 2000
- Applications with high requirements with regard to the torque to be transmitted and the damping characteristics

PEX



- Fail-safe plug-in/jaw coupling with flexible elements
- Sizes: 58 – 250
- Applications with increased requirements regarding torque and damping capabilities

RIGID COUPLINGS

GEAR COUPLING GC



- Greased curved bevel gear coupling
- Sizes: 50 – 165
- Applications with highest to maximum requirements regarding transmitted torque

CLAMP COUPLING



- Easy-to-assemble shaft connection
- Sizes: 10 – 180
- Simple and easy-to-assemble shaft connections with no specific requirements for damping capabilities

FLANGE COUPLING



- Easy-to-assemble and particularly robust shaft connection
- Sizes: 25 – 500
- Simple, particularly robust and easy-to-assemble shaft connections with no specific requirements regarding damping capabilities

CLAMP COUPLING



- Easy-to-assemble shaft connection
- Sizes: 10 – 220
- Simple and easy-to-assemble shaft connections with no specific requirements for damping capabilities
- Steel / stainless steel

MINI COUPLING



- Slotted, backlash-free and very heat-resistant rigid clamp coupling
- Sizes: 16 – 80
- Applications with lower requirements with regard to the torque to be transmitted and the damping characteristics. Ideal for restricted installation spaces.

SERVICE TOOLS



ALSO AS
RFID
VERSION

SERVICE TOOLS

optibelt SERVICE KIT

SERVICE CASE

Cost-effective environmental protection and thus ways to reduce energy and costs can be achieved quickly and easily by simple means. The objective should be to operate existing power drives in a more cost-effective manner, and by implementing every suggestion to immediately have a positive impact on the environment. This increases the effective performance and makes the total cost of drives with Optibelt belts and pulleys understandable for everyone.

Implementing measures to reduce costs and energy can be done quickly and easily using simple means, such as technical devices. The wide range of Optibelt service options has been expanded a step further.

The practical **optibelt SERVICE KIT** contains a number of technical devices that can be used to carry out a series of optimisations on existing drives.



optibelt TT / TT RFID / TT DATA FREQUENCY TENSION TESTER

The **optibelt TT** frequency tension tester is used to check the tension of drive belts by measuring their frequency of vibration. Due to its compact design, it offers universal application possibilities for drives in engineering, in the automotive industry and for many other technical applications.

The **optibelt TT** is designed even for difficult-to-reach places, making it ideal for quickly and easily checking the tension of V-belts, ribbed belts and timing belts.

optibelt LASER POINTER II ALIGNMENT OF BELT DRIVES

The **optibelt LASER POINTER II** makes it easier to align belt drives. The belt pulleys are aligned with each other via the front or lateral faces. The **optibelt LASER POINTER II** is simple to handle and can be fixed in place in a matter of seconds. This is a practical aid for professional alignment of belt pulleys.



optibelt SERVICE BOX FOR QUICK HELP ON SITE

The **optibelt SERVICE BOX** was designed as an on-site support for many fields of application. Drive centre distances, belt lengths and pulley diameters can be determined trouble-free with the flexible fabric measuring tape.

optibelt NOTEBOX TENSION NOTEBOX

The proven Optibelt "Tension Notes" stickers document the default values for the proper tensioning methods whenever required and so provide service technicians with reliable information in future without the need for a long search.



optibelt
MEASURING GAUGE
INNER LENGTH MEASURING
GAUGE

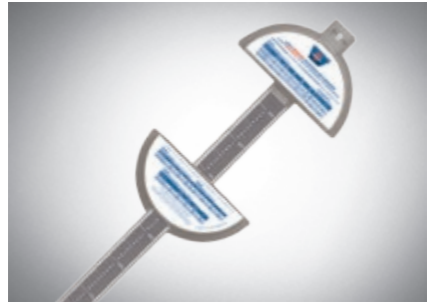

The **optibelt MEASURING GAUGE** is the perfect aid for measuring inner lengths. The possible measuring range is between 500 and 3550 mm.

optibelt
OPTIKRIK 0, I, II, III
TENSION MEASURING DEVICE



Tension gauges check if the V-belt, the kraftband or the ribbed belt is running properly in your vehicle. The tension gauges are easy to use. Our field service team will be happy to assist you.

optibelt
V-BELTS AND PULLEY
GROOVE TEMPLATE



Valuable help for the measurement of V-belt and pulley groove profiles

optibelt
CUT II
BELT SLITTER



The **optibelt CUT II** belt slitter was specifically developed for modern storage for the technical trade.

optibelt
FRICTION WELDING TOOL
RS02
SPLICING TOOL



For round, wedge and special profiles

optibelt
BASIC AND
PREMIUM CASE
SPLICING TOOL



These five-piece sets (including welding tool and guiding tongs) allow urethane belts to be welded quickly and easily. The basic equipment is suitable for occasional use, the premium equipment for daily use.

OPTIBELT SOFTWARE

optibelt CAD
PULLEYS AND BUSHES
IN 2D/3D

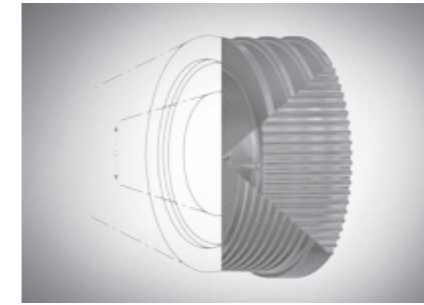

Download CAD files for the standard product range of pulleys and bushes in 2D and 3D models

optibelt CAP
MULTI-PULLEY
TIMING BELT RANGE



With this software, the user can design simple 2-pulley drives or calculate the correct timing belt for complicated multi-pulley drives.

Those who do not yet own CAP software can register on the Optibelt website.